

# **EOM-G103-PHR-PTP Series Hardware User's Manual**

---

**First Edition, January 2015**

[www.moxa.com/product](http://www.moxa.com/product)

**MOXA<sup>®</sup>**

© 2015 Moxa Inc. All rights reserved.

# EOM-G103-PHR-PTP Series Hardware User's Manual

The software described in this manual is furnished under a license agreement and may be used only in accordance with the terms of that agreement.

## Copyright Notice

© 2015 Moxa Inc., All rights reserved.

## Trademarks

The MOXA logo is a registered trademark of Moxa Inc.  
All other trademarks or registered marks in this manual belong to their respective manufacturers.

## Disclaimer

Information in this document is subject to change without notice and does not represent a commitment on the part of Moxa.

Moxa provides this document as is, without warranty of any kind, either expressed or implied, including, but not limited to, its particular purpose. Moxa reserves the right to make improvements and/or changes to this manual, or to the products and/or the programs described in this manual, at any time.

Information provided in this manual is intended to be accurate and reliable. However, Moxa assumes no responsibility for its use, or for any infringements on the rights of third parties that may result from its use.

This product might include unintentional technical or typographical errors. Changes are periodically made to the information herein to correct such errors, and these changes are incorporated into new editions of the publication.

## Technical Support Contact Information

[www.moxa.com/support](http://www.moxa.com/support)

### **Moxa Americas**

Toll-free: 1-888-669-2872

Tel: +1-714-528-6777

Fax: +1-714-528-6778

### **Moxa Europe**

Tel: +49-89-3 70 03 99-0

Fax: +49-89-3 70 03 99-99

### **Moxa China (Shanghai office)**

Toll-free: 800-820-5036

Tel: +86-21-5258-9955

Fax: +86-21-5258-5505

### **Moxa Asia-Pacific**

Tel: +886-2-8919-1230

Fax: +886-2-8919-1231

# Table of Contents

<b>1. Introduction</b> .....	<b>1-1</b>
Overview .....	1-2
Package Checklist .....	1-2
Product Features .....	1-2
EOM-G103-PHR-PTP Hardware Specifications .....	1-3
EOM-G103-PHR-PTP Hardware Block Diagram .....	1-3
Appearance.....	1-4
EOM-G103-PHR-PTP Embedded Module.....	1-4
EOM-G103-PHR-PTP Evaluation Board.....	1-4
Dimensions (unit: mm) .....	1-5
<b>2. EOM-G103-PHR-PTP Functionality</b> .....	<b>2-1</b>
EOM-G103-PHR-PTP Embedded Module Functions .....	2-2
LAN Ports .....	2-2
Console Port .....	2-2
GPIO .....	2-2
Pin Assignments .....	2-2
Pin assignment table for JP1 (2 x 40).....	2-3
Pin assignment table for JP2 (2 x 10).....	2-3
<b>3. EOM-G103-PHR-PTP-ST Functionality</b> .....	<b>3-1</b>
EOM-G103-PHR-PTP-ST Development Board .....	3-2
Combining the EOM-G103-PHR-PTP-ST with the Embedded Module.....	3-2
LED Indicators.....	3-3
Wiring Requirements.....	3-4
Connecting the Power .....	3-4
LAN Ports and Pin Assignments .....	3-4
Reset Button .....	3-5
<b>4. PCB Layout and Design Guidelines</b> .....	<b>4-1</b>
General Rules.....	4-2
Power Ground Rules.....	4-2
Chassis Ground .....	4-2
Magnetic Noise Zone.....	4-3
Differential Signal Layout.....	4-3
USB Signal Layout .....	4-3
Heat Sink Requirements .....	4-3
Design Guidelines .....	4-4

## Introduction

---

Thank you for purchasing the Moxa EOM-G103-PHR-PTP embedded module. The product's features include four 10/100 Mbps Ethernet ports and one UART serial port. The EOM-G103-PHR-PTP is ideal as the core module of an industrial embedded system design.

The EOM-G103-PHR-PTP Evaluation Kit, which is designed for system and software program development at the system evaluation stage, is also available. The kit includes the EOM-G103-PHR-PTP and EOM-G103-PHR-PTP-ST, which is the carrier board used to evaluate the EOM-G103-PHR-PTP.

In this manual, we introduce the hardware features and functions of the EOM-G103-PHR-PTP embedded module and the EOM-G103-PHR-PTP Evaluation Kit. After a brief introduction to the hardware features, the manual focuses on installation and hardware configuration with device interfaces.

The following topics are covered in this chapter:

- **Overview**
- **Package Checklist**
- **Product Features**
- **EOM-G103-PHR-PTP Hardware Specifications**
- **EOM-G103-PHR-PTP Hardware Block Diagram**
- **Appearance**
  - EOM-G103-PHR-PTP Embedded Module
  - EOM-G103-PHR-PTP Evaluation Board
  - Dimensions (unit: mm)

## Overview

The EOM-G103-PHR-PTP full Gigabit managed redundancy modules are designed for device manufacturers who would like to embed and integrate the advanced functionality of IEC 62439-3 supported modules. The EOM-G103-PHR-PTP embedded modules provide enhanced performance and reliability for certain mission-critical applications, but with minimal effort.

IEC 62439-3 Clause 4 (PRP) and IEC 62439-3 Clause 5 (HSR) are the newest standardized redundancy protocols for industrial automation networks where zero recovery time is needed. PRP and HSR are suitable for electrical substation automation and other mission-critical applications that cannot tolerate any system downtime.

The EOM-G103-PHR-PTP series modules are compliant with the latest IEC 62439-3 standards and provide an easy and cost-effective integrated solution for adding a redundancy module to a non-IEC 62439-3 supported product. The modules support two IEC 62439-3 Ethernet ports (SGMII (MAC mode) or SERDES(1000Base-X) interface) for constructing PRP or HSR networks and one standard Ethernet port (SGMII (MAC mode) or SERDES(1000Base-X) interface) for connecting with standard IEEE 802.3 Ethernet devices. The EOM-G103-PHR-PTP series also provide an extra SGMII (MAC mode) or SERDES(1000Base-X) interface for building up a local access Ethernet console port to easily maintain, control, and manage certain devices right at the local site.

## Package Checklist

The EOM-G103-PHR-PTP package includes the EOM-G103-PHR-PTP embedded module only. The EOM-G103-PHR-PTP Evaluation Kit is available separately for evaluation purposes. The EOM-G103-PHR-PTP Evaluation Kit package contains the following items:

- One EOM-G103-PHR-PTP embedded module
- One EOM-G103-PHR-PTP-ST, the carrier board of the EOM-G103-PHR-PTP evaluation kit
- Ethernet cable
- USB-IF cable
- Universal power adapter
- Warranty card

<b>NOTE</b> Please notify your sales representative if any of the above items are missing or damaged.
---

## Product Features

The EOM-G103-PHR-PTP embedded module has the following features:

- ARM9 32-bit 192 MHz processor
- On-board 32 MB RAM, 16 MB flash
- Two 10/100/1000Base Ethernet ports for PRP or HSR redundant networks and one 10/100/1000Base Ethernet port for network switching
- One UART serial port for console control
- Compact size for easy integration at any field site
- Full-function evaluation kit for quick evaluation and application development
- Wide -40 to 85°C operating temperature

# EOM-G103-PHR-PTP Hardware Specifications

## Technology

### Standards:

- IEEE 802.3 for 10BaseT
- IEEE 802.3u for 100BaseT(X) and 100BaseFX
- IEEE 802.3ab for 1000BaseT(X)
- IEEE 802.3z for 1000BaseX

**Protocols:** PRP/HSR

### Interface

- Ethernet Ports:** 3 10/100/1000Base ports
- Connectors:** 1 connector with 2 x 40 pins, and 1 connector with 2 x 10 pins
- Console Port:** 10/100/1000 Mbps Ethernet console port or USB console
- GPIO:** 3 programmable I/O pins

### Power Requirements

- Input Voltage:** 3.3 V
- Input Current:** 1.625 W @ 3.3 V

### Physical Characteristics

- Dimensions:** 80 x 1.6 x 65 mm (3.15 x 0.06 x 2.56 in)
- Weight:** 28.6 g (0.06 lb)

### Environmental Limits

- Operating Temperature:** -40 to 85°C (-40 to 185°F)
- Storage Temperature:** -40 to 85°C (-40 to 185°F)
- Ambient Relative Humidity:** 5 to 95% (non-condensing)

### Standards and Certifications

**EMI:** FCC Part 15 Subpart B Class A, EN 55022 Class A, CE Class A

**Note:** Please check Moxa's website for the most up-to-date certification status.

### Warranty

- Warranty Period:** 5 years
- Details:** See [www.moxa.com/warranty](http://www.moxa.com/warranty)

# EOM-G103-PHR-PTP Hardware Block Diagram

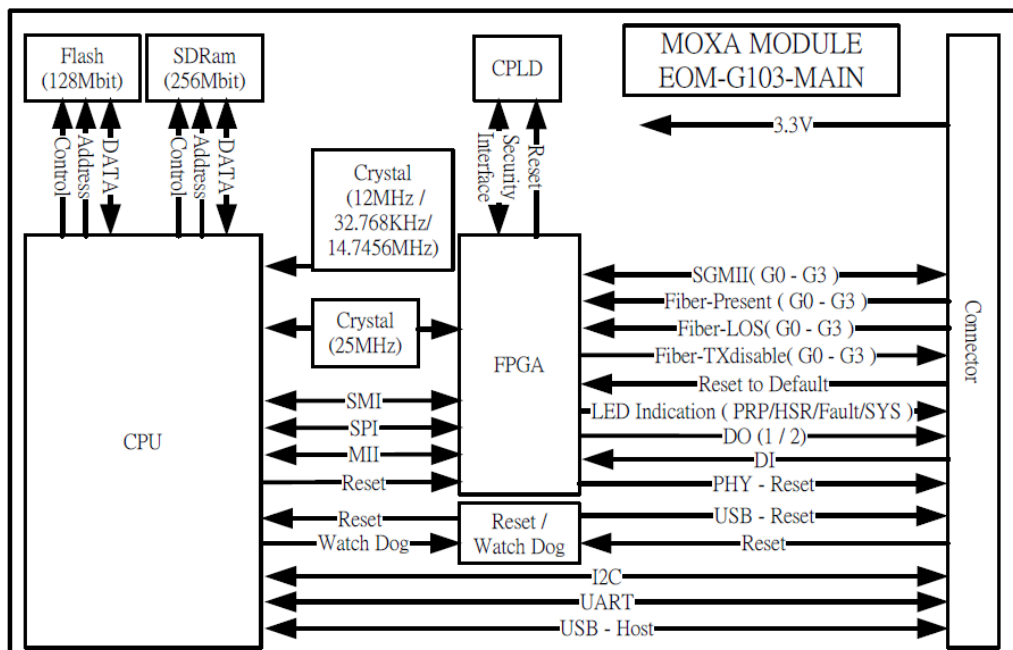

# Appearance

## EOM-G103-PHR-PTP Embedded Module

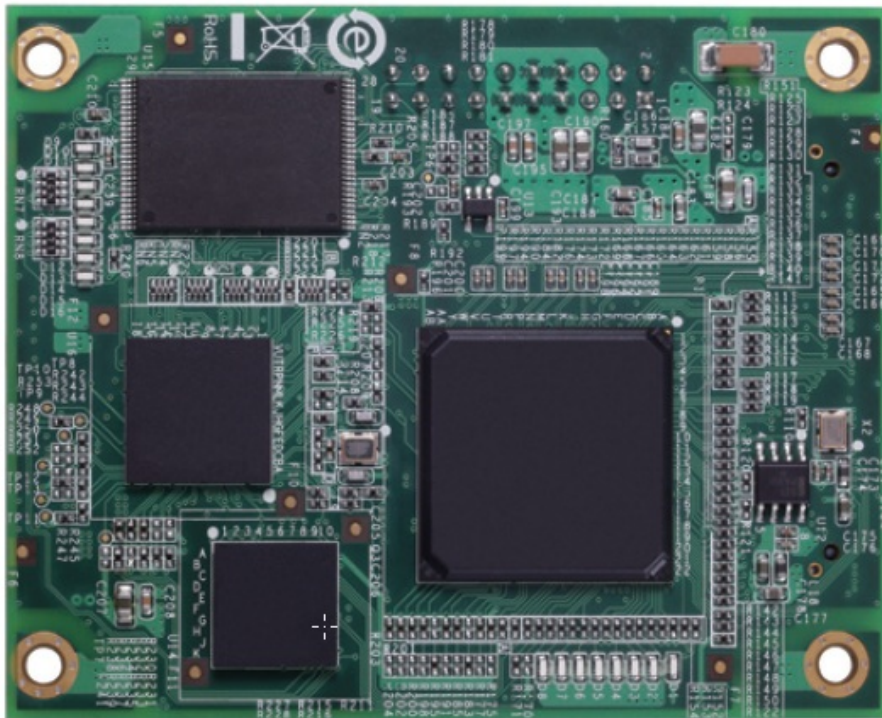

## EOM-G103-PHR-PTP Evaluation Board

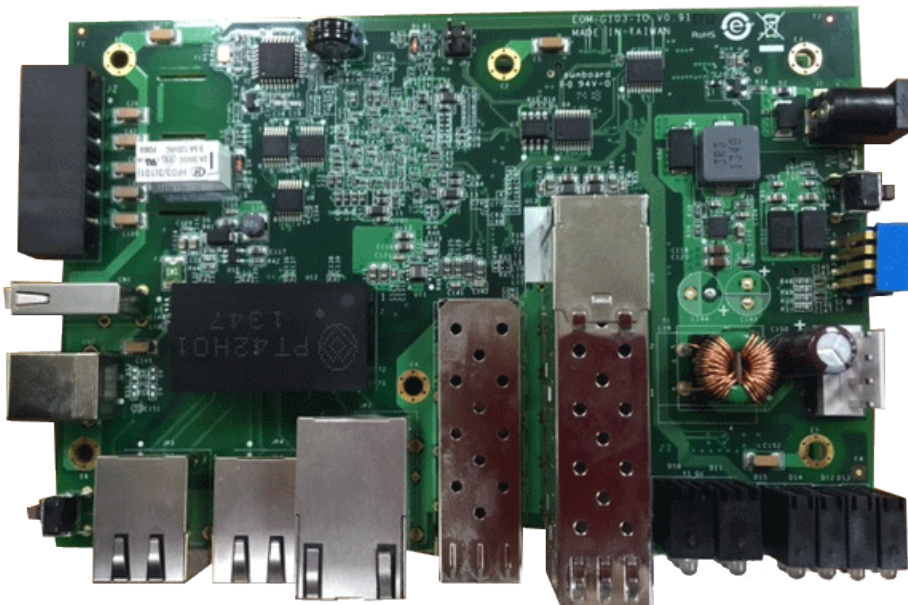





# EOM-G103-PHR-PTP Functionality

---

In this chapter, we introduce the basic features of the EOM-G103-PHR-PTP embedded module.

The following topics are covered in this chapter:

- ❑ **EOM-G103-PHR-PTP Embedded Module Functions**

- LAN Ports

- ❑ **Console Port**

- ❑ **GPIO**

- ❑ **Pin Assignments**

- Pin assignment table for JP1 (2 x 40)

- Pin assignment table for JP2 (2 x 10)

# EOM-G103-PHR-PTP Embedded Module Functions

## LAN Ports

The EOM-G103-PHR-PTP embedded module has three 10/100/1000 Mbps SGMII (MAC mode) / SERDES (1000Base-X) LAN ports that can be used to set up a redundant PRP/HSR network.

## Console Port

The EOM-G103-PHR-PTP embedded module has 1 10/100/1000 Mbps Ethernet console port or USB console port for onsite configuration.

## GPIO

The EOM-G103-PHR-PTP embedded module provides 3 software-selectable GPIOs with one input and two outputs. The GPIOs give users the ability to design customized functionality.

## Pin Assignments

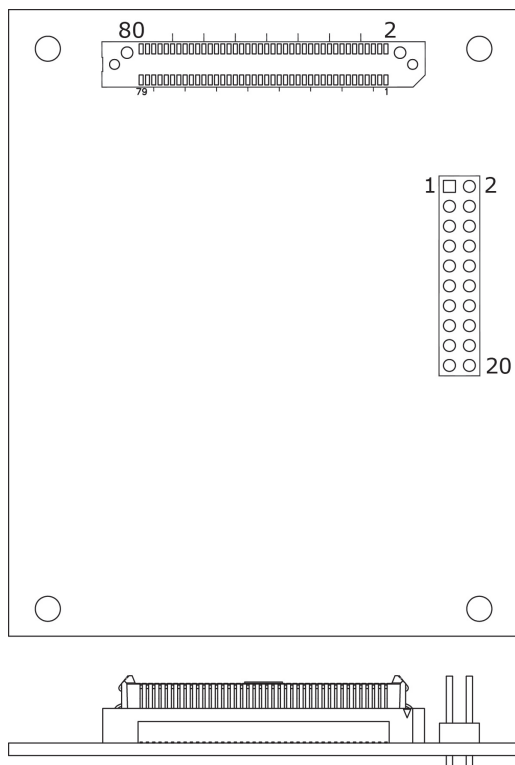

## Pin assignment table for JP1 (2 x 40)

Pin	Signal	Pin	Signal	Pin	Signal	Pin	Signal
1	GND	2	GND	41	PRP_LED	42	DI
3	DTR(UART)	4	DCD(UART)	43	FAULT_LED	44	Reserved
5	RTS(UART)	6	DSR(UART)	45	STAT_R_LED	46	Reserved
7	TXD(UART)	8	CTS(UART)	47	STAT_G_LED	48	Reserved
9	GND	10	RXD(UART)	49	TX_DIS_G3(SFP)	50	GND
11	GXB_RX_P_0(SGMII)	12	GND	51	PRESENT_G3(SFP)	52	Reserved
13	GXB_RX_N_0(SGMII)	14	GXB_TX_P0(SGMII)	53	LOS_G3(SFP)	54	Reserved
15	GND	16	GXB_TX_N0(SGMII)	55	TX_DIS_G2(SFP)	56	GND
17	GXB_RX_P_1(SGMII)	18	GND	57	PRESENT_G2(SFP)	58	SDA-(I2C)
19	GXB_RX_N_1(SGMII)	20	GXB_TX_P1(SGMII)	59	LOS_G2(SFP)	60	SCK-(I2C)
21	GND	22	GXB_TX_N1(SGMII)	61	TX_DIS_G1(SFP)	62	GND
23	GXB_RX_P_2(SGMII)	24	GND	63	PRESENT_G1(SFP)	64	MDIO-PHY(SMI)
25	GXB_RX_N_2(SGMII)	26	GXB_TX_P2(SGMII)	65	LOS_G1(SFP)	66	MDC-PHY(SMI)
27	GND	28	GXB_TX_N2(SGMII)	67	TX_DIS_G0(SFP)	68	GND
29	GXB_RX_P_3(SGMII)	30	GND	69	PRESENT_G0(SFP)	70	Reserved
31	GXB_RX_N_3(SGMII)	32	GXB_TX_P3(SGMII)	71	LOS_G0(SFP)	72	Reserved
33	GND	34	GXB_TX_N3(SGMII)	73	Reserved	74	GND
35	COUP_LED	36	GND	75	Reserved	76	USB-HOST-DP
37	QB_LED	38	DO(1)	77	Reserved	78	USB-HOST-DM
39	HSR_LED	40	DO(0)	79	Reserved	80	GND

## Pin assignment table for JP2 (2 x 10)

Pin	Signal	Pin	Signal
1	Reserved	2	Reserved
3	Reserved	4	Reserved
5	Reserved	6	Reserved
7	3.3V	8	3.3V
9	3.3V	10	3.3V
11	3.3V	12	GND
13	GND	14	GND
15	GND	16	GND
17	Reset_PHY	18	Reset
19	Reserved	20	Reset to Default

Signal	JP1 pin#	Pin Name	Pin Type	Description	
SGMII/SerDes	11	GXB_RX_P_0	I	Port A.Receive pairs.Differential Input data.	
	13	GXB_RX_N_0			
		14	GXB_TX_P_0	O	Port A.Transmit pairs.Differential Output data.
		16	GXB_TX_N_0		
		17	GXB_RX_P_1	I	Port B.Receive pairs.Differential Input data.
		19	GXB_RX_N_1		
		20	GXB_TX_P_1	O	Port B.Transmit pairs.Differential Output data.
		22	GXB_TX_N_1		
		23	GXB_RX_P_2	I	InterLink.Receive pairs.Differential Input data.
		25	GXB_RX_N_2		
		26	GXB_TX_P_2	O	InterLink.Transmit pairs.Differential Output data.
		28	GXB_TX_N_2		
	29	GXB_RX_P_3	I	Ethernet cosnsole.Receive pairs.Differential Input	

	31	GXB_RX_N_3		data.
	32	GXB_TX_P_3	O	Ethernet cosnsole. Transmit pairs. Differential Output data.
	34	GXB_TX_N_3		
UART	4	DCD	I	Data carrier detect. It operate at 3.3V.
	7	TXD	O	Serial output data. It operate at 3.3V.
	10	RXD	I	Serial input data. It operate at 3.3V.
	3	DTR	O	Data terminal ready. It operate at 3.3V.
	6	DSR	I	Data set ready. It operate at 3.3V.
	5	RTS	O	Request to send. It operate at 3.3V.
	8	CTS	I	Clear to send. It operate at 3.3V.
LED indication	39	HSR_LED	O	HSR Mode status LED. Active Low. It operate at 3.3V.
	41	PRP_LED	O	PRP Mode status LED. Active High. It operate at 3.3V.
	43	FAULT_LED	O	Fault indication LED. Active Low. The system is operating abnormally. It operate at 3.3V.
	45	STAT_R_LED	O	System information LED. Active Low. The System has passed self-diagnosis test on boot-up and is ready to run. It operate at 3.3V.
	47	STAT_G_LED	O	System information LED. Active Low. The System has failed self-diagnosis test on boot-up and is ready to run. It operate at 3.3V.
FIBER_TX_DISABLE	67	TX_DIS_G0	O	The TX_DISABLE signal is high to turn off the laser output. The laser will turn on when TX_DISABLE is low. Active Low. G0(port A). G1(port B). G2(InterLink). G3(Ethernet Console). It operate at 3.3V.
	61	TX_DIS_G1		
	55	TX_DIS_G2		
	49	TX_DIS_G3		
FIBER_PRESENT	69	PRESENT_G0	I	SFP module Detect. Active low. Singal-ended input reference signal from fiber optical module. This pins must be pull high 4.7Kohm. G0(port A). G1(port B). G2(InterLink). G3(Ethernet Console). It operate at 3.3V.
	63	PRESENT_G1		
	57	PRESENT_G2		
	51	PRESENT_G3		
Fiber_LOS	71	LOS_G0	I	Fiber Signal Detect. Active low. Singal-ended input reference signal from fiber optical module. This pins must be pull high 4.7Kohm. G0(port A), G1(port B), G2(InterLink), G3(Ethernet Console). It operate at 3.3V.
	65	LOS_G1		
	59	LOS_G2		
	53	LOS_G3		
MII Management Interface	64	MDIO-PHY	I/O PU	Management data I/O. It operate at 3.3V. The input data value on the MDIO pin is valid and latched on the rising edge of MDC.
	66	MDC-PHY	O	Management data clock. It operate at 3.3V. The chip sources a 2MHz clock to the external Phy device
I2C	58	SDA	I/O PU	Serial data line. It operate at 3.3V.
	60	SCK	O	Serial data clock. It operate at 3.3V.
USB interface	76	USB-HOST-DP	I/O	USB Data +. Host side.
	78	USB-HOST-D M	I/O	USB Data -. Host side.
Digatal output	38	DO(1)	O	General Purpose Output. It operate at 3.3V.
	40	DO(0)		
Digatal input	42	DI	I	General Purpose Input. It operate at 3.3V.

POWER	1,2,9,12,1 5,18,21,24 ,27,30,33, 36,50,56,6 2,68,74,80	GND	GND	Ground.
Reserved	35,37,44,4 6,48,52,54 ,70,72,73, 75,77,79			Do Not Connect. These pins should not be connected. Do not connect these pins together.

Signal	JP2 pin#	Pin Name	Pin Type	Description
Reset	17	Reset_PHY	O	Active Low. Reset the PHY chip. It operate at 3.3V.
	18	Reset	I	Active Low. Reset the MOXA module. It operate at 3.3V.
	20	Reset to Default	I	Active Low. The low status for five continuous seconds to load the factory default settings. It operate at 3.3V.
Power	7 - 11	3.3V	PWR	POWER. 3.3V.
	12 -16	GND	GND	Ground.
Reserved	1-6,19	Reserved		Do Not Connect. These pins should not be connected. Do not connect these pins together.

Type	Description
I	Input
O	Output
I/O	Input/Output
PWR	POWER
GND	GROUND
PU	Internal pull-up resistor

## **EOM-G103-PHR-PTP-ST Functionality**

---

This chapter includes information about the EOM-G103-PHR-PTP-ST (carrier board of the EOM-G103-PHR-PTP Evaluation Kit).

The following topics are covered in this chapter:

- ❑ **EOM-G103-PHR-PTP-ST Development Board**
- ❑ **Combining the EOM-G103-PHR-PTP-ST with the Embedded Module**
- ❑ **LED Indicators**
- ❑ **Wiring Requirements**
- ❑ **Connecting the Power**
- ❑ **LAN Ports and Pin Assignments**
- ❑ **Reset Button**

# EOM-G103-PHR-PTP-ST Development Board

The EOM-G103-PHR-PTP Evaluation Kit is a PCB board with complete layout. The kit helps users evaluate, develop, and integrate the EOM-G103-PHR-PTP embedded module into their systems and applications. Simply combine the EOM-G103-PHR-PTP embedded module with the Evaluation Kit to start porting the relevant software, and create a solution for the applications you wish to implement.

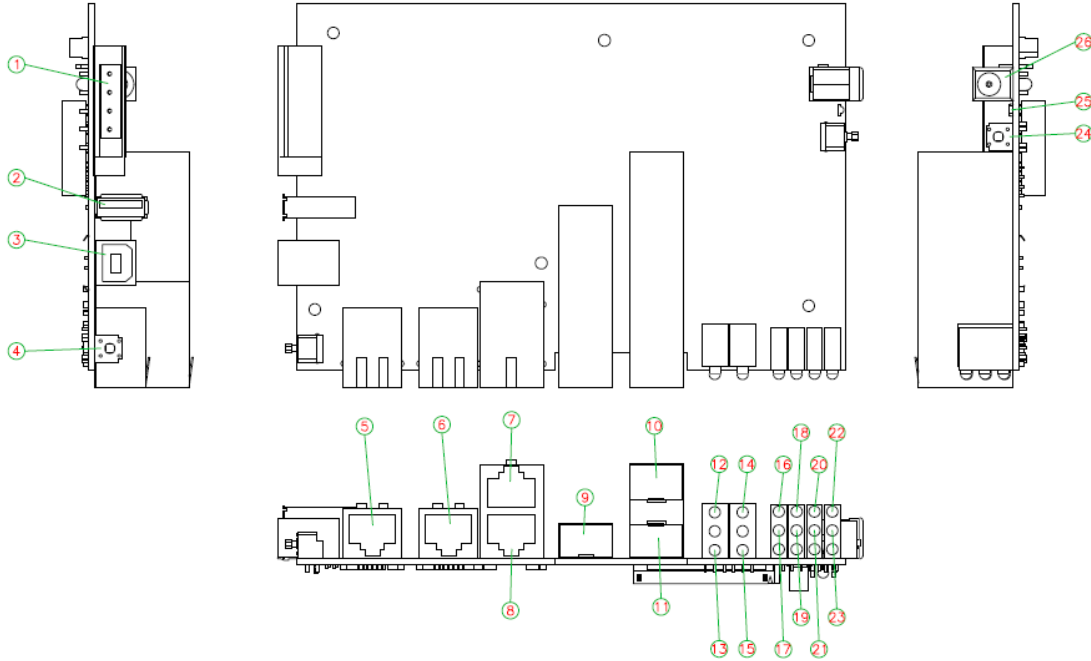

Number	Description
1	Terminal block for DI and Relay
2	USB storage port(ABC-02-USB-T)
3	USB console port
4	Reset to factory default by pressing and hold the button for 5 seconds
5	Ethernet Console port: 10/100/1000BaseT(X)
6	Interlink port: 10/100/1000BaseT(X)
7	PRP/HSR redundant port A: 10/100/1000BaseT(X)
8	PRP/HSR redundant port B: 10/100/1000BaseT(X)
9	Interlink port: 100/1000BaseFX
10	PRP/HSR redundant port A: 100/1000BaseFX
11	PRP/HSR redundant port B: 100/1000BaseFX
24	System reboot
25	DO(1) (LED Display)
26	Power input

## Combining the EOM-G103-PHR-PTP-ST with the Embedded Module

Insert the EOM-G103-PHR-PTP embedded module vertically onto the EOM-G103-PHR-PTP-ST. Note that the Pin marked "JP1 and JP2" on the embedded module must be matched with the Pin marked "JP4 and JP5" on the EOM-G103-PHR-PTP-ST. Be careful when installing the board to avoid damaging the pins.

# LED Indicators

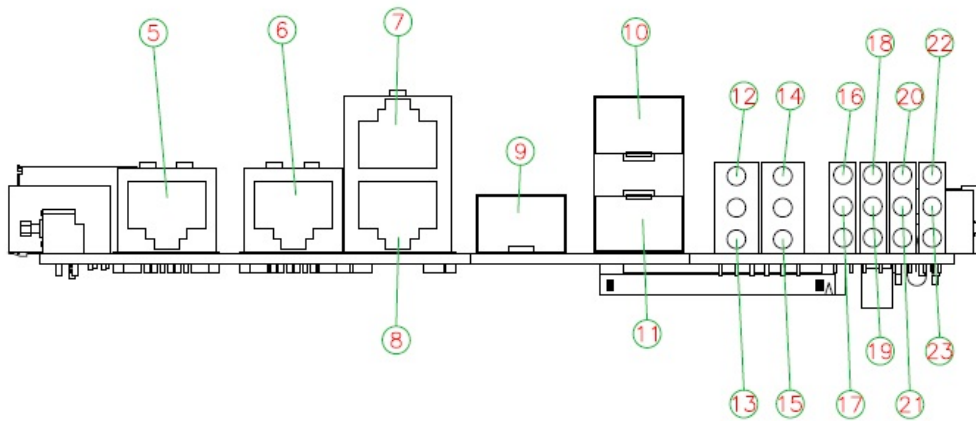

Number	LED	Color	State	Description
22	PWR 1	amber	ON	Power is being supplied to the main system's power input PWR1
			OFF	Power is not being supplied to the main system's power input PWR1
20	STATE	green	ON	System has passed self-diagnosis test on boot-up and is ready to run
			blinking	1. System is undergoing the self-diagnosis test 2. System detects the ABC-02 USB plugged into the USB storage port 3. Blinks once per second when pressing the reset button for 5 seconds 4. Blinks rapidly when the reset button has been pressed continuously for 5 seconds, indicating that the device will be reset to factory defaults
		red	ON	System failed self-diagnosis on boot-up. • RAM Test Fail / System Info. Read Fail / Switch Initial Fail / PTP PHY Error. • FW Checksum Fail / Uncompress Fail (+ Green Coupler lit on: SW FAIL)
21	FAULT	red	ON	1. System has failed, or is under quick inspection 2. The relay signal contact is open 3. ABC-02 loading/saving failure
			OFF	The system is operating normally
18	PRP	green	ON	PRP is working
			OFF	PRP is not enabled
19	HSR	green	ON	HSR is working
			OFF	HSR is not enabled
12(Console) 13(Interlink) 14(A) 15(B)	Link/Act/ Speed	green	ON	When there is a secure connection (or link) to a 1000 Mbps device on any port.
			blinking	When data is being transmitted or received at 1000 Mbps.
		amber	ON	When there is a secure connection (or link) to 10/100 Mbps Ethernet device on any port.
			blinking	When data is being transmitted or received at 10/100 Mbps.
			OFF	Link down or no link



# Wiring Requirements

In this section, we describe how to connect the EOM-G103-PHR-PTP Evaluation Kit to devices.

Read the following safety precautions before proceeding with the installation of any electronic device:

- Use separate paths to route wiring for power and devices. If power wiring and device wiring paths must cross, make sure the wires are perpendicular at the intersection point.  
**NOTE:** Do not run signal or communication wiring and power wiring in the same wire conduit. To avoid interference, wires with different signal characteristics should be routed separately.
- Use the type of signal transmitted through a wire to determine which wires should be kept separate. The rule of thumb is that wiring that shares similar electrical characteristics can be bundled together.
- Keep input wiring and output wiring separate.
- It is advisable to label the wiring to all devices in the system.
- Be sure to disconnect the power cord before installing and/or wiring your EOM-G103-PHR-PTP Evaluation Kit.



## ATTENTION

### Safety First!

Be sure to disconnect the power cord before installing and/or wiring your EOM-G103-PHR-PTP Evaluation Kit.

## Connecting the Power

You may use the power jack for connecting the power. The power input range of the EOM-G103-PHR-PTP Evaluation Kit is from 12 VDC. If the power is properly supplied, the "Power" LED will light up in yellow after 3 to 5 seconds.

### Power Ground Rules:

Do not split the ground plane into separate planes for analog, digital, and power pins. A single, contiguous ground plane is recommended.

- Route high-speed signals above a solid and unbroken ground plane.
- Fill copper in the unused area of signal planes and connect these coppers to the ground plane through vias.
- Stagger the placement of vias to avoid creating long gap in the plane due to via voids.

## LAN Ports and Pin Assignments

The EOM-G103-PHR-PTP Evaluation Kit has four 10/100/1000 Mbps LAN ports for connecting to a network. The LAN ports use 8-pin RJ45 connectors. See the following diagram for the pinouts.

8-pin RJ45	Pin	Signal
	1	TRD(0)+
	2	TRD(0)-
	3	TRD(1)+
	4	TRD(2)+
	5	TRD(2)-
	6	TRD(1)-
	7	TRD(3)+
	8	TRD(3)-

## Reset Button

The EOM-G103-PHR-PTP Evaluation Kit has two reset buttons: **Manual Reset** and **Reset to Default**.

Press the **Manual Reset** button to reset the hardware of the EOM-G103-PHR-PTP Evaluation Kit and the EOM-G103-PHR-PTP embedded module.

Press the **Reset** button continuously for at least 5 seconds to load the software factory default configuration. After the factory default configuration has been loaded, the system will reboot automatically.

# PCB Layout and Design Guidelines

---

This chapter includes information about using the EOM-G103-PHR-PTP embedded module to design products that comply with the EMI standard.

The printed circuit board is the single most important factor that affects EMI and overall performance. In order to meet these requirements, it depends on good design practices. The goal here is to minimize digital and common mode noise as well as to provide shielding between the PCB's internal circuitry and the external environment. These PCB design practices should apply to the entire PCB design.

The following topics are covered in this chapter:

- ❑ **General Rules**
- ❑ **Power Ground Rules**
- ❑ **Chassis Ground**
- ❑ **Magnetic Noise Zone**
- ❑ **Differential Signal Layout**
- ❑ **USB Signal Layout**
- ❑ **Heat Sink Requirements**
- ❑ **Design Guidelines**

## General Rules

- Place components so as to avoid long loop traces.
- Use a metal box to shield the printed circuit board.
- Use a ferrite core on the DC power cord to reduce EMI.
- Provide controlled impedance on all high-speed digital signal traces with the right termination schemes to prevent reflection and ringing.
- Ensure that the power line is rated for the application and optimized with decoupling capacitors.
- Keep power and ground noise under 100 mV peak to peak.
- Ensure that the switching DC-DC converter is filtered and properly shielded as the DC-DC power converter can produce a great deal of EMI noise.
- Avoid via and pad in the path on any critical signal as via and pad will induce unwanted capacitance and inductance which can cause reflection and distortion.

## Power Ground Rules

- Do not split the ground plane into separate planes for analog, digital, and power pins. A single, contiguous ground plane is recommended.
- Route high-speed signals above a solid and unbroken ground plane.
- Fill copper in the unused area of signal planes and connect these coppers to the ground plane through vias.
- Stagger the placement of vias to avoid creating long gap in the plane due to via voids.

## Chassis Ground

The chassis ground and magnetics serve two purposes: they help to reduce EMI noise emissions from the signal ground plane to the PCB's external environment, and act as a shield to protect the PCB components from ESD. Place the chassis ground on all PCB layers and use connection mounting holes to join the chassis ground on different PCB layers. The chassis ground on the PCB is directly connected to the metal shield of the equipment through the connection mounting holes. Use a trench/moat to isolate the chassis ground plane from the signal ground plane. The chassis ground region extends from the front edge of the PCB board (RJ45 connectors) to the magnetics and around the edge of the board as shown below.

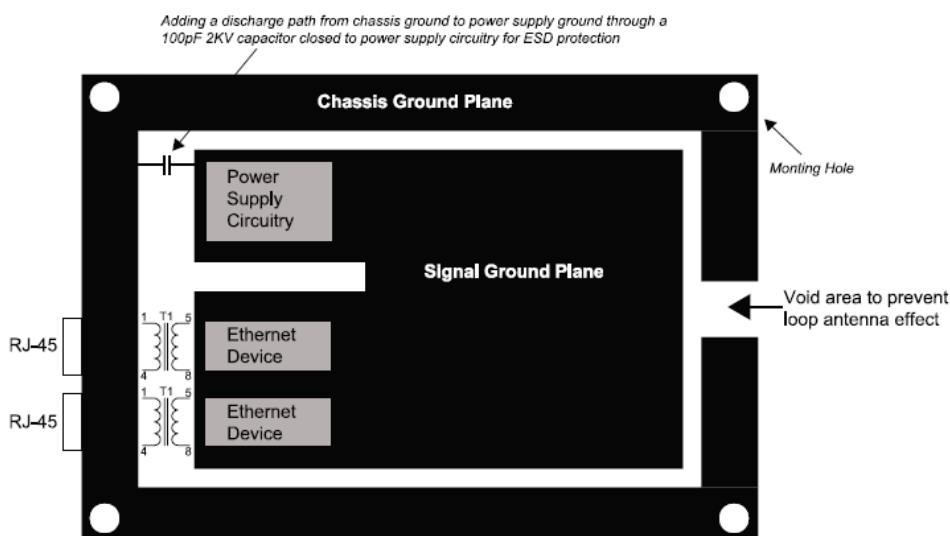

## Magnetic Noise Zone

- Void both power and ground planes on all PCB layers directly under the magnetics.
- The chassis ground should extend from the magnetics to the RJ45 connector.
- Do not route any digital signals between the PHY and RJ45 connector.
- Add transformer to Port 1 and Port 2 as shown in figure 3 when connecting to external cable is required.

## Differential Signal Layout

- Differential pair (GXB\_TX\_P/N or GXB\_RX\_P/N) should be routed away from all other signals and keeps 100 ohms differential Impedance.
- Keep both traces of each differential pair as identical to each other as possible.
- Route each differential pair on the same PCB layer.
- Route both (GXB\_TX\_P/N or GXB\_RX\_P/N) pairs far away from each other at least 20 mil space as shown below.
- The transmit, receive, and clock signals should be kept away from each other.
- Do not space single-ended and differential pair traces close than threes the height above the nearest plane

## USB Signal Layout

The following layout guidelines apply to the USB\_DP and USB\_DM differential pair signals:

- Route the signals close to each other as parallel traces on the PCB, and not parallel with other non-USB signal traces to minimize crosstalk.
- Doubling the space from the USB\_DP/USB\_DM signal pair to adjacent signal traces helps prevent crosstalk. Do not worry about crosstalk between the two USB\_DP/USB\_DM signal traces. Also can adopt the ground guard get up the USB\_DP/USB\_DM signal pair wrapping to decrease crosstalk and EMI.
- The USB\_DP/USB\_DM signal traces must also be the same length. This minimizes the effect of common mode current on EMI. Lastly do not route over plane splits.
- The trace impedance for the USB\_DP/USB\_DM signals should be  $45W \pm 10\%$  (to ground). The impedance is  $90W \pm 10\%$  between the differential signal pairs USB\_DP and USB\_DM to match the  $90W \pm 10\%$  USB twisted pair cable impedance. The trace impedance can be controlled by carefully selecting the line width, trace distance from power or ground planes, and physical proximity of nearby traces.
- Do not forget the USB data line must be make the impedance matching finally, to avoid the signal reflection.
- Minimize the length of high-speed clock and periodic signal traces that run parallel to high speed USB signal lines to minimize crosstalk.
- Based on EMI testing experience, the minimum suggested spacing to clock signals is 50 mils.
- Based on simulation data, use 20-mil minimum spacing between high-speed USB signal pairs and other signal traces for optimal signal quality. This helps to prevent crosstalk

## Heat Sink Requirements

Chip	Part reference	Tc (case temperature)
MOXA ART	U16	109°C (228.2°F)
FPGA EP4CGX75CF23I7N	P1	90°C (194°F)

# Design Guidelines

You may quickly enable the PRP/HSR function on the System by integrating the EOM-G103-PHR-PTP Series to the main system board. The configuration and communication interfaces between the system main board and EOM-G103-PHR-PTP module are UART and SGMII (MAC mode) and SERDES (1000Base-X), respectively. All management and IP-based functions are activated by the System main board and the EOM-G103-PHR-PTP series provide several functions, including PRP/HSR redundancy protocols, VLAN filtering, Multicast filtering, and time zone settings (refer to the user’s manual for details).

