

MGate 5119 Series User's Manual

Version 1.0, February 2022

www.moxa.com/product



© 2022 Moxa Inc. All rights reserved.

MGate 5119 Series User's Manual

The software described in this manual is furnished under a license agreement and may be used only in accordance with the terms of that agreement.

Copyright Notice

© 2022 Moxa Inc. All rights reserved.

Trademarks

The MOXA logo is a registered trademark of Moxa Inc.
All other trademarks or registered marks in this manual belong to their respective manufacturers.

Disclaimer

Information in this document is subject to change without notice and does not represent a commitment on the part of Moxa.

Moxa provides this document as is, without warranty of any kind, either expressed or implied, including, but not limited to, its particular purpose. Moxa reserves the right to make improvements and/or changes to this manual, or to the products and/or the programs described in this manual, at any time.

Information provided in this manual is intended to be accurate and reliable. However, Moxa assumes no responsibility for its use, or for any infringements on the rights of third parties that may result from its use.

This product might include unintentional technical or typographical errors. Changes are periodically made to the information herein to correct such errors, and these changes are incorporated into new editions of the publication.

Technical Support Contact Information

www.moxa.com/support

Moxa Americas

Toll-free: 1-888-669-2872
Tel: +1-714-528-6777
Fax: +1-714-528-6778

Moxa Europe

Tel: +49-89-3 70 03 99-0
Fax: +49-89-3 70 03 99-99

Moxa India

Tel: +91-80-4172-9088
Fax: +91-80-4132-1045

Moxa China (Shanghai office)

Toll-free: 800-820-5036
Tel: +86-21-5258-9955
Fax: +86-21-5258-5505

Moxa Asia-Pacific

Tel: +886-2-8919-1230
Fax: +886-2-8919-1231

Table of Contents

1. Introduction	1-1
Overview	1-1
2. Hardware	2-1
Power Input and Relay Output Pinouts.....	2-2
LED Indicators.....	2-2
Dimensions	2-3
Pin Assignments	2-3
Hardware Installation Procedure	2-4
Reset Button	2-5
Pull-High, Pull-Low, and Terminator for RS-485	2-5
microSD	2-5
3. Getting Started	3-1
Connecting the Power	3-2
Connecting Serial Devices.....	3-2
Connecting to a Network	3-2
Installing DSU Software.....	3-2
Log In to the Web Console.....	3-3
4. Web Console Configuration and Troubleshooting	4-1
Overview	4-2
Basic Settings	4-2
Network Settings.....	4-3
Serial Settings.....	4-4
Protocol Settings (Agent Mode)	4-4
Protocol Settings—Protocol Conversion	4-5
Protocol Settings—Modbus TCP Client (Master) Settings.....	4-6
Protocol Settings—Modbus RTU/ASCII Master Settings.....	4-9
Protocol Settings—IEC 60870-5-104 Client Settings.....	4-10
Protocol Settings—IEC 60870-5-101 Master Settings	4-14
Protocol Settings—DNP3 TCP/UDP Master Settings	4-19
Protocol Settings—DNP3 Serial Master Settings	4-25
Protocol Settings—IEC 61850 Server Settings	4-25
System Management.....	4-31
System Management—Accessible IP List.....	4-31
System Management—DoS Defense	4-32
System Management—System Log Settings.....	4-33
System Management—Auto Warning Settings	4-34
System Management—Email Alert	4-34
System Management—SNMP Trap	4-34
System Management—SNMP Agent	4-35
System Management—LLDP Settings	4-36
System Management—Certificate	4-36
System Management—Misc. Settings	4-36
System Management—Maintenance	4-39
System Monitoring (Troubleshooting).....	4-41
System Monitoring—System Status	4-41
System Monitoring—Protocol Status.....	4-43
Status Monitoring	4-48
5. Configuration (Text Mode Console)	5-1
6. Network Management Tool (MXstudio)	6-1
A. SNMP Agents with MIB II and RS-232-Like Groups	A-1
RFC1213 MIB-II Supported SNMP Variables	A-2
RFC1317 RS-232-Like Groups	A-3

Introduction

Welcome to the MGate 5119 series of protocol gateways designed for the power industry, featuring easy protocol conversion between Modbus RTU/ASCII/TCP, IEC 60870-5-101/104, DNP3 TCP/serial and IEC 61850 MMS protocols. This chapter is an introduction to the MGate 5119 Series.

Overview

The MGate 5119 is a protocol gateway that is mainly dedicated to substation automation applications. To integrate existing Modbus, IEC 60870-5-101/104, or DNP3 TCP serial devices into an IEC 61850 MMS network, use the MGate 5119 as a Modbus master or IEC 60870-5-101/104 or DNP3 master to collect data and exchange data with an IEC 61850 MMS system.

2

Hardware

The following topics are covered in this chapter:

- ❑ **Power Input and Relay Output Pinouts**
- ❑ **LED Indicators**
- ❑ **Dimensions**
- ❑ **Pin Assignments**
- ❑ **Hardware Installation Procedure**
- ❑ **Reset Button**
- ❑ **Pull-High, Pull-Low, and Terminator for RS-485**
- ❑ **microSD**

Power Input and Relay Output Pinouts



	V2+	V2-				V1+	V1-
Shielded Ground	DC Power Input 2	DC Power Input 2	N.O.	Common	N.C.	DC Power Input 1	DC Power Input 1

LED Indicators

Agent Mode:

LED	Color	Description
Ready	Off	Power is off or a fault condition exists
	Green	Steady: Power is on, and the MGate is functioning normally
	Red	Steady: Power is on, and the MGate is booting up
		Blinking slowly: Indicates an IP conflict, or the DHCP or BOOTP server is not responding properly
MB/101/104/DNP3	Off	No communication with a Modbus/DNP3/101/104 device
	Green	Normal Modbus/DNP3/101/104 communication is in progress
	Red	When the MGate 5119 acts as a Modbus master: <ol style="list-style-type: none"> Received an exception code from the slave device Received a framing error (parity error, checksum error) Timeout (the master sent a request but no response was received) When the MGate 5119 acts as an IEC 60870-5-101/104 or a DNP3 master: <ol style="list-style-type: none"> Received an outstation exception (format error, checksum error, invalid data, outstation responds are not supported) Timeout (the outstation sent no response)
850	Off	No communication with an IEC 61850 system
	Green	Normal IEC 61850 communication is in progress
	Red	When the MGate 5119 acts as an IEC 61850 server: <ol style="list-style-type: none"> Received an abnormal packet (wrong format, unsupported function code) Failed to establish an IEC 61850 connection Disconnected the IEC 61850 connection

Dimensions

Unit: mm (inch)

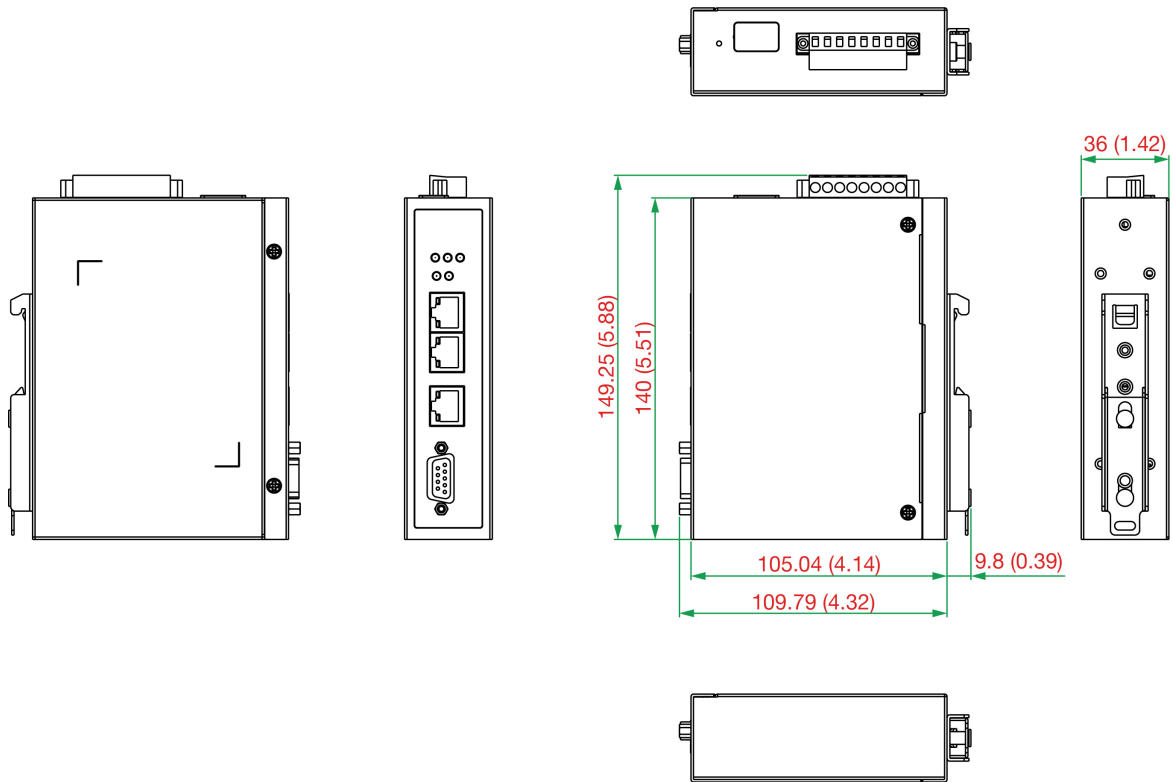

Pin Assignments

Serial Port (Male DB9)

Pin	RS-232	RS-422/RS-485 (4W)	RS-485 (2W)
1	DCD	TxD-(A)	-
2	RXD	TxD+(B)	-
3	TXD	RxD+(B)	Data+(B)
4	DTR	RxD-(A)	Data-(A)
5*	GND	GND	GND
6	DSR	-	-
7	RTS	-	-
8	CTS	-	-
9	-	-	-

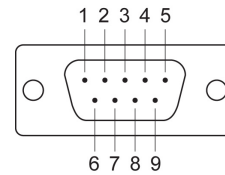

*Signal ground

Ethernet Port (RJ45)

Pin	Signal
1	Tx+
2	Tx-
3	Rx+
6	Rx-

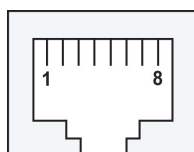

Console Port (RS-232)

The MGate 5119 Series can use a RJ45 serial port to connect to a PC for device configuration.

Pin	RS-232
1	DSR
2	RTS
3	GND
4	TXD
5	RXD
6	DCD
7	CTS
8	DTR

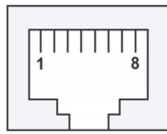

Hardware Installation Procedure

1. Connect the MGate 5119's terminal block to the power supply, which could provide 12 to 48 VDC.
2. Use a serial or Ethernet cable to connect the MGate to the Modbus RTU/ASCII/TCP, DNP3 Serial/TCP, IEC60870-5-101/104 device.
3. Use an Ethernet cable to connect the MGate to the IEC 61850 system.
4. The MGate 5119 can be attached to a DIN rail or mounted on a wall. For DIN-rail mounting, push down the spring and properly attach it to the DIN rail until it "snaps" into place. For wall mounting, install the wall-mount kit (optional) first and then screw the device onto the wall. An M3 screw is suggested, and the minimum length of the screw should be 10 mm.

The following figure illustrates the two mounting options:

Wall-Mount Installation

DIN-Rail Installation

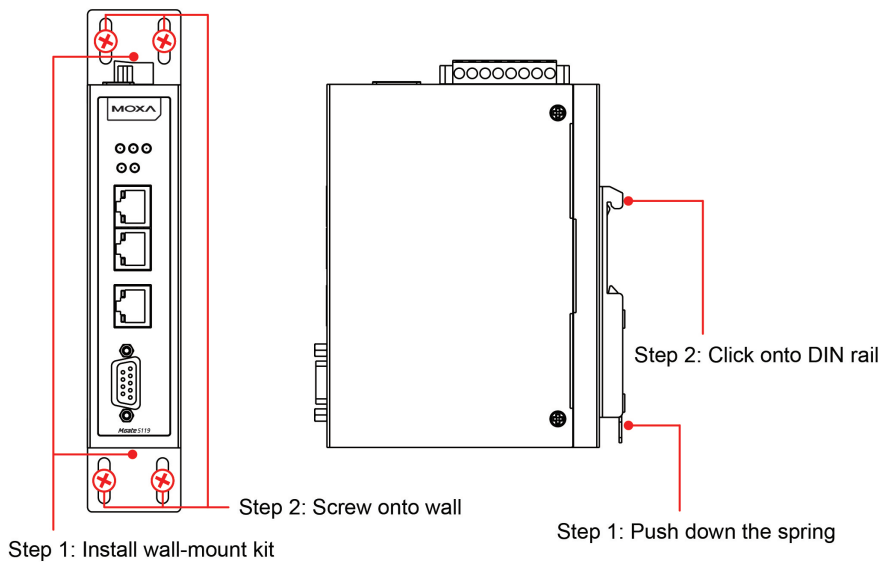

Malfunctioning MGate replacement

1. Replace the malfunctioning MGate with a new MGate.
2. Insert the microSD card into the new MGate.
3. Power on the MGate.
4. The configuration file stored on the microSD card will automatically copy to the MGate.

microSD card writing failure

The following circumstances may cause the microSD card to experience a writing failure:

1. The microSD card has less than 20 Mbytes of free space remaining.
2. The microSD card is write-protected.
3. The file system is corrupted.
4. The microSD card is damaged.

The MGate will stop working in case of the above events, accompanied by a flashing Ready LED and beeping alarm. When you replace the MGate gateway's microSD card, the microSD card will synchronize the configurations stored on the MGate gateway. Note that the replacement microSD card should not contain any configuration files on it; otherwise, the out-of-date configuration will copy to the MGate device.

3

Getting Started

The following topics are covered in this chapter:

- ❑ **Connecting the Power**
- ❑ **Connecting Serial Devices**
- ❑ **Connecting to a Network**
- ❑ **Installing DSU Software**
- ❑ **Log In to the Web Console**

Connecting the Power

The unit can be powered by connecting a power source to the terminal block:

1. Loosen or remove the screws on the terminal block.
2. Turn off the power source and then connect a 12–48 VDC power line to the terminal block.
3. Tighten the connections, using the screws on the terminal block.
4. Turn on the power source.

Note that the unit does not have an on/off switch. It automatically turns on when it receives power. The PWR LED on the top panel will glow to show that the unit is receiving power. For power terminal block pin assignments, refer to the **Power Input and Relay Output Pinout** section in *chapter 2*.

Connecting Serial Devices

The MGate 5119 supports Modbus serial devices. Before connecting or removing the serial connection, first make sure the power is turned off. For the serial port pin assignments, see the **Pin Assignments** section in *chapter 2*.

Connecting to a Network

Connect one end of the Ethernet cable to the MGate's 10/100M Ethernet port and the other end of the cable to the Ethernet network. The MGate will show a valid connection to the Ethernet in the following ways:

- The Ethernet LED maintains a solid green color when connected to a 100 Mbps Ethernet network.
- The Ethernet LED maintains a solid orange color when connected to a 10 Mbps Ethernet network.
- The Ethernet LED will flash when Ethernet packets are being transmitted or received.

Installing DSU Software

If you do not know the MGate gateway's IP address when setting it up for the first time (default IP is *192.168.127.254*); use an Ethernet cable to connect the host PC and MGate gateway directly. If you connect the gateway and host PC through the same Ethernet switch, make sure there is no router between them. You can then use the **Device Search Utility (DSU)** to detect the MGate gateways on your network. You can download DSU (Device Search Utility) from Moxa's website: www.moxa.com.

The following instructions explain how to install the DSU, a utility to search for MGate 5119 units on a network.

1. Locate and run the following setup program to begin the installation process:

dsu_setup_[Version]_Build_[DateTime].exe

This version might be named **dsu_setup_Ver2.x_Build_xxxxxxx.exe**

2. The Welcome window will greet you. Click **Next** to continue.
3. When the **Select Destination Location** window appears, click **Next** to continue. You may change the destination directory by first clicking on **Browse...**
4. When the **Select Additional Tasks** window appears, click **Next** to continue. You may select **Create a desktop icon** if you would like a shortcut to the DSU on your desktop.
5. Click **Install** to copy the software files.
6. A progress bar will appear. The procedure should take only a few seconds to complete.
7. A message will show the DSU has been successfully installed. You may choose to run it immediately by selecting **Launch DSU**.
8. You may also open the DSU through **Start → Programs → MOXA → DSU**.

The DSU window should appear as shown below.

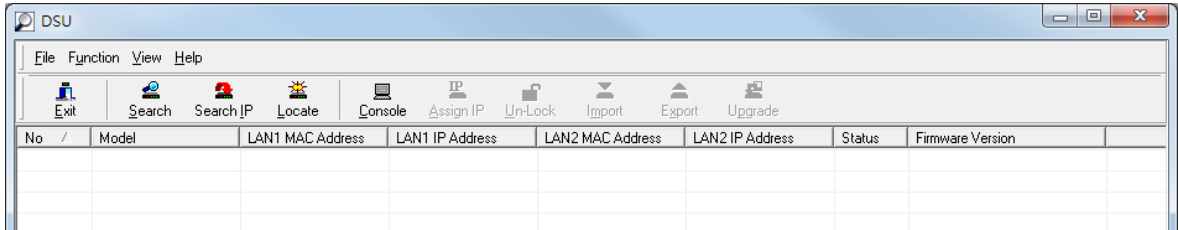

Click **Search** and a new Search window will pop up.

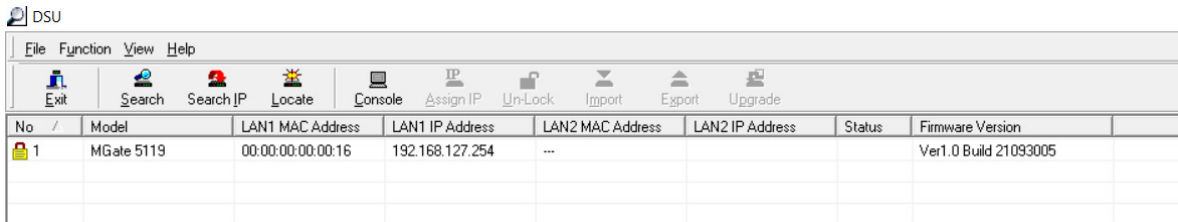

Log In to the Web Console

Use the Web console to configure the MGate through Ethernet or verify the MGate’s status. Use a web browser, such as Microsoft Internet Explorer or Google Chrome to connect to the MGate, using the HTTP/HTTPS protocol.

When the MGate gateway appears on the DSU device list, select the gateway and right-click the mouse button to open a web console to configure the gateway.

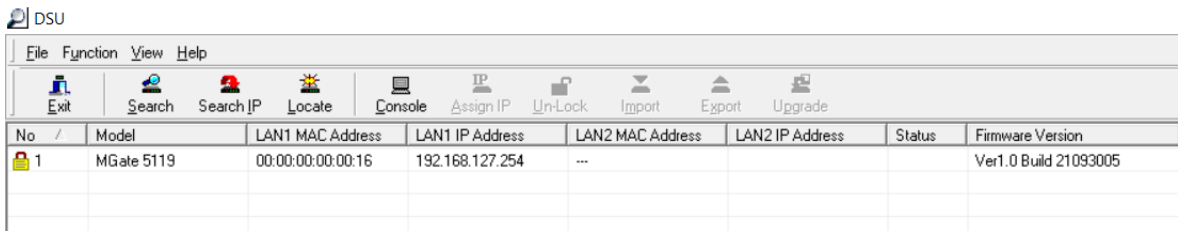

On the first page of the web console, enter **admin** for the default Account name and **moxa** for the default Password.

The screenshot shows a login form with two input fields. The 'Account' field contains the text 'admin'. The 'Password' field contains four dots, indicating a masked password. Below the fields is a green button with the text 'Login'.

When you log in the web console for the first time, a message will pop up. Emphasizing a higher security level, we suggest you change the password.

Welcome to the MGate 5119	
Model name	MGate 5119
Serial No.	MOXA00000016
Firmware version	1.0 Build 21093005
Ethernet IP address	192.168.127.254
Ethernet MAC address	00:00:00:00:00:16
Up time	0 days 01h:17m:52s
Power 1	On
Power 2	Off
microSD	Not Detected

Change the password in the following path: **System Management** → **Misc. Settings** → **Account Management**

Web Console Configuration and Troubleshooting

This chapter provides a quick overview of how to configure the MGate 5119 by web console.

The following topics are covered in this chapter:

- ❑ **Overview**
- ❑ **Basic Settings**
- ❑ **Network Settings**
- ❑ **Serial Settings**
- ❑ **Protocol Settings (Agent Mode)**
 - Protocol Settings—Protocol Conversion
 - Protocol Settings—Modbus TCP Client (Master) Settings
 - Protocol Settings—Modbus RTU/ASCII Master Settings
 - Protocol Settings—IEC 60870-5-104 Client Settings
 - Protocol Settings—IEC 60870-5-101 Master Settings
 - Protocol Settings—DNP3 TCP/UDP Master Settings
 - Protocol Settings—DNP3 Serial Master Settings
 - Protocol Settings—IEC 61850 Server Settings
- ❑ **System Management**
 - System Management—Accessible IP List
 - System Management—DoS Defense
 - System Management—System Log Settings
 - System Management—Auto Warning Settings
 - System Management—Email Alert
 - System Management—SNMP Trap
 - System Management—SNMP Agent
 - System Management—LLDP Settings
 - System Management—Certificate
 - System Management—Misc. Settings
 - System Management—Maintenance
- ❑ **System Monitoring (Troubleshooting)**
 - System Monitoring—System Status
 - System Monitoring—Protocol Status
- ❑ **Status Monitoring**

Overview

This section gives an overview of the MGate 5119 status.

Welcome to the MGate 5119

Model name	MGate 5119
Serial No.	MOXA00000016
Firmware version	1.0 Build 21111701
Ethernet IP address	192.168.127.254
Ethernet MAC address	00:00:00:00:00:16
Up time	0 days 00h:00m:23s
Power 1	On
Power 2	Off
microSD	Not Detected

Basic Settings

On this webpage, you can change the name of the device and time zone settings.

Basic Settings

Server Settings

Server name

Server location

Time Settings

Time zone

Local time / / : :

Time source

Time server

Server Setting

Parameter	Value	Description
Server name	(an alphanumeric string)	You can enter a name to help you identify the unit, such as the function, etc.
Server location	(an alphanumeric string)	You can enter a name to help you identify the unit location. Such as "Cabinet A001."

Time Settings

The MGate 5119 has a built-in Real-Time Clock for time calibration functions. Functions such as the log function can add real-time information to the message.



ATTENTION

First-time users should select the time zone first. The console will display the "real time" according to the time zone relative to GMT. If you would like to modify the real-time clock, select **Local time**. MGate's firmware will modify the GMT time according to the Time Zone.

Parameter	Value	Description
Time zone	User's selectable time zone	This field shows the currently selected time zone and allows you to select a different time zone.
Local time	User's adjustable time	(1900/1/1-2037/12/31)
Time server	IP or Domain address (e.g., 192.168.1.1 or time.stdtime.gov.tw)	This optional field specifies your time server's IP address or domain name if a time server is used on your network. The module supports SNTP (RFC-1769) for automatic time calibration. The MGate will request time information from the specified time server every 10 minutes.
Time source	NTP	



ATTENTION

If the dispersion of the time server is higher than the client (MGate), the client will not accept NTP messages from the time server. MGate's dispersion is 1 second. You must configure your time server with a dispersion value lower than 1 sec for the NTP process to complete.

Network Settings

The Network Settings is where the unit's network settings are configured. You can change the IP Configuration, IP Address, Netmask, Default Gateway, and DNS.

Network Settings

Network Settings

IP configuration Static ▼

IP address

Netmask

Gateway

DNS server 1

DNS server 2

Parameter	Value	Description
IP configuration	Static IP, DHCP, BOOTP	Select Static IP if you are using a fixed IP address. Select one of the other options if the IP address is set dynamically.
IP address	192.168.127.254 (or other 32-bit number)	The IP (Internet Protocol) address identifies the server on the TCP/IP network.
Netmask	255.255.255.0 (or other 32-bit number)	This identifies the server as belonging to a Class A, B, or C network.
Gateway	0.0.0.0 (or other 32-bit number)	This is the IP address of the router that provides network access outside the server's LAN.
DNS server 1	0.0.0.0 (or other 32-bit number)	This is the IP address of the primary domain name server.
DNS server 2	0.0.0.0 (or other 32-bit number)	This is the IP address of the secondary domain name server.

Serial Settings

The MGate 5119’s serial interface supports RS-232, RS-422, and RS-485 interfaces. You must configure the baudrate, parity, data bits, and stop bits before using the serial interface with Modbus RTU/ASCII or IEC 60870-5-101 or DNP3 serial protocol. Incorrect settings will cause communication failures.

Serial Settings

Port	Baud rate	Parity	Data bit	Stop bit	Flow control	FIFO	Interface	RTS on delay	RTS off delay
1	115200	Even	8	1	None	Enable	RS-232	0	0

Parameter	Value	Description
Baudrate	50 bps to 921600 bps	
Parity	None, Odd, Even, Mark, Space	
Data bits	7,8	
Stop bits	1, 2	
Flow control	None, RTS/CTS, RTS Toggle	The RTS Toggle will turn off RTS signal when there is no data to be sent. If there is data to be sent, the RTS toggle will turn on the RTS signal before a data transmission and off after the transmission is completed.
FIFO	Enable, Disable	The internal buffer of UART. Disabling FIFO can reduce the latency time when receiving data from serial communications, but this will also slow down the throughput.
Interface	RS-232, RS-422, RS-485 2-wire, RS-485 4-wire	
RTS on delay	0 to 100 ms	Only available for RTS Toggle
RTS off delay	0 to 100 ms	Only available for RTS Toggle

RTS Toggle

The RTS Toggle function is used for **RS-232** mode only. This flow-control mechanism is achieved by toggling the RTS pin in the transmission direction. When activated, data will be sent after the RTS pin is toggled ON for the specified time interval. After the data transmission is finished, the RTS pin will toggle OFF for the specified time interval.

Protocol Settings (Agent Mode)

A typical MGate 5119 application comprises a PSCADA as a client/master and a field device as a server/slave. Both these components use different protocols and hence need a gateway in between to exchange data. In its capacity as a gateway, the MGate acts as the server/slave when it is connected to PSCADA and as the client/master when it is connected to a field device. Therefore, to configure an MGate, you must:

1. Select the correct protocols in the **Protocol Conversion** setting.
2. Configure MGate’s Role 1 and Role 2.

NOTE We suggest you configure the master side first and then the slave side.

The following sections contain detailed MGate configuration instructions organized as per the above outline.

Protocol Settings—Protocol Conversion

The MGate 5119 brings Modbus, DNP3, and IEC 60870-5-101/104 devices to an IEC 61850 system. In the protocol conversion setting: role 1 of the MGate 5119 is fixed to an IEC 61850 server that is connected to an IEC 61850 client; role 2 of the MGate 5119 can be Modbus, DNP3, IEC 60870-5-101/104 master that connects to slave devices.

For instance, if your device is a Modbus RTU slave, the device setting should be configured as a Modbus RTU/ASCII slave; role 2 of the MGate 5119 will change to a Modbus RTU/ASCII master accordingly.

Below is the protocol combinations of the MGate 5119.

Protocol Conversion

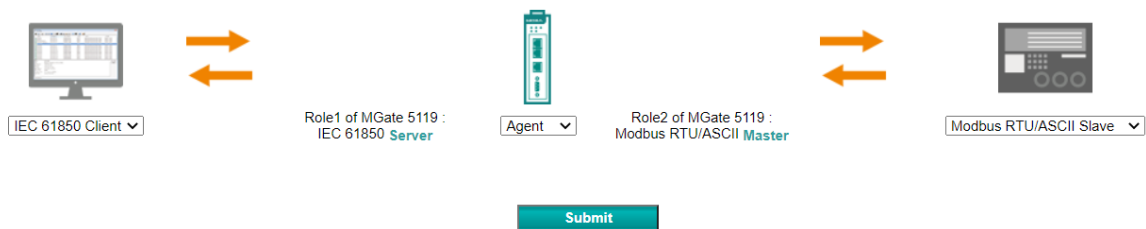

Device 1	Device 2
IEC 61850 client	Modbus RTU/ASCII slave
IEC 61850 client	Modbus TCP server
IEC 61850 client	IEC 60870-5-101 slave
IEC 61850 client	IEC 60870-5-104 server
IEC 61850 client	DNP3 TCP/UDP outstation
IEC 61850 client	DNP3 serial outstation

After protocol selection, we have to configure each side of MGate’s role. In a typical application, one side of MGate will be set as a server/slave while the other side will be set as a client/master. You will find the corresponding lists under **Protocol Settings**. The following configuration settings are possible:

- A1. Modbus TCP Client (Master) Settings
- A2. Modbus RTU/ASCII Master Settings
- A3. IEC 60870-5-104 Client Settings
- A4. IEC 60870-5-101 Master Settings
- A5. DNP3 TCP/UDP Master Settings
- A6. DNP3 Serial Master Settings
- A7. IEC 61850 Server Settings

Protocol Settings—Modbus TCP Client (Master) Settings

Modbus TCP Settings

Role: Client

Client Settings

Initial delay: (0 - 30000 ms)

Max. retry: (0 - 5)

Response timeout: (10 - 120000 ms)

Modbus Commands

Index	Name	Slave IP Address	Slave ID	Function	Address / Quantity	Trigger	Poll Interval	Endian Swap	Data Type
+ Add Edit Clone Delete Move									

Client Settings

Parameter	Value	Default	Description
Initial delay	0 to 30000 ms	0	Some Modbus slaves may take more time to boot up than other devices. In some environments, this may cause the entire system to suffer from repeated exceptions during the initial boot-up. After booting up, you can force the MGate to wait before sending the first request with the Initial Delay setting.
Max. retry	0 to 5	3	This is used to configure how many times the MGate will try to communicate with the Modbus slave when the Modbus command times out.
Response timeout	10 to 120000 ms	1000	Based on the Modbus standard, the device manufacturer defines the time taken by a slave device to respond to a request. A Modbus master can be configured to wait a certain amount of time for a slave’s response. If no response is received within the specified time, the master will disregard the request and continue operation. This allows the Modbus system to continue the operation even if a slave device is disconnected or faulty. On the MGate 5119, the Response timeout field is used to configure how long the gateway will wait for a response from a Modbus slave. Refer to your device manufacturer’s documentation to manually set the response timeout.

Add Modbus Commands

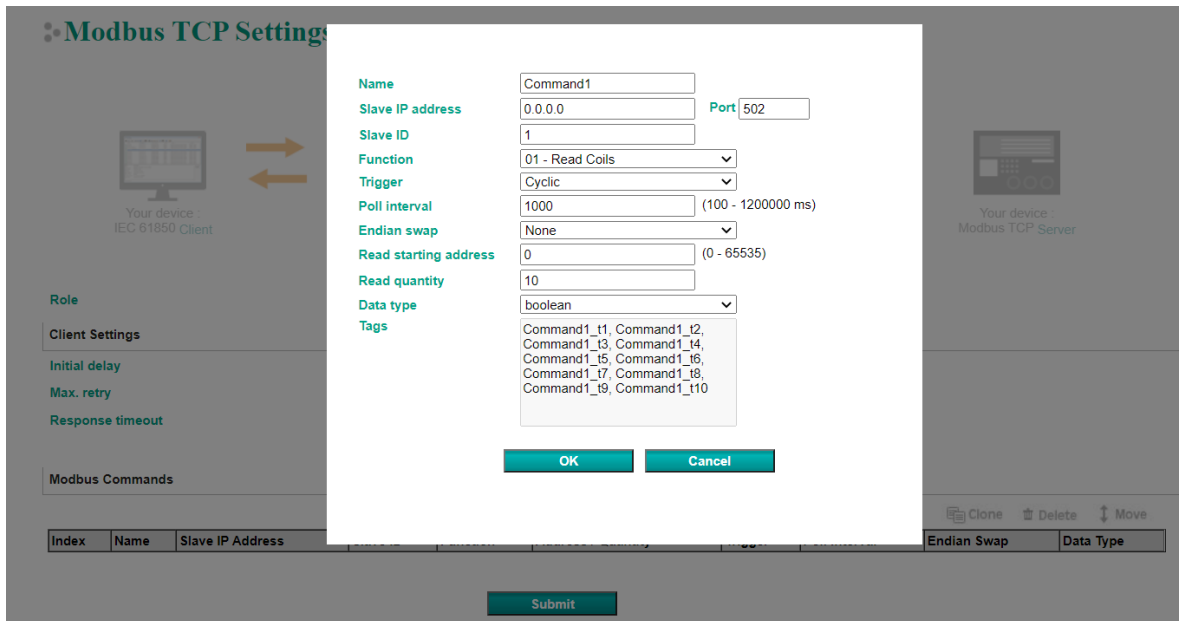

Parameter	Value	Default	Description
Name	(an alphanumeric string)	Command1	Max. 32 characters.
Slave IP address	0.0.0.0 to 255.255.255.255	0.0.0.0	The IP address of a remote slave device.
Port	1 to 65535	502	The TCP port number of a remote slave device.
Slave ID	1 to 255	1	The Modbus slave ID.
Function	1 – Read Coils 2 – Read Discrete Inputs 3 – Read Holding Registers 4 – Read Inputs Registers 5 – Write Single Coil 6 – Write Single Register 15 – Write Multiple Coils 16 – Write Multiple Registers 23 – Read/Write Multiple Registers		When a message is sent from a Client to a Server device, the function code field tells the server what kind of action to perform.
Trigger	Cyclic Data Change Disable		Disable: The command is never sent Cyclic: The command is sent cyclically at the interval specified in the Poll Interval parameter. Data change: The data area is polled for changes at the time interval defined by Poll Interval. A command is issued when a change in data is detected.
Poll interval	100 to 1200000 ms	1000	Polling intervals are in milliseconds. Since the module sends all requests in turns, the actual polling interval also depends on the number of requests in the queue and their parameters. The range is from 100 to 1,200,000 ms.

Parameter	Value	Default	Description
Endian swap	None Byte Word Byte and Word	None	Data Byte Swapping None: Don't need to swap Byte: 0x0A, 0x0B, 0x0C, 0x0D becomes 0x0B, 0x0A, 0x0D, 0x0C Word: 0x0A, 0x0B, 0x0C, 0x0D becomes 0x0C, 0x0D, 0x0A, 0x0B. Byte and Word: 0x0A, 0x0B, 0x0C, 0x0D becomes 0x0D, 0x0C, 0x0B, 0x0A.
Read starting address	0 to 65535	0	Modbus register address.
Read quantity	Read Coils: 1 to 2000 Read Discrete Inputs: 1 to 2000 Read Inputs Registers: 1 to 125 Read Holding Registers: 1 to 125 Read/Write Multiple Registers: 1 to 125	10	Specifying how many items to read.
Write starting address	0 to 65535	0	Modbus register address.
Write quantity	Write Multiple Coils: 1 to 1968 Write Multiple Registers: 1 to 123 Read/Write Multiple Registers: 1 to 123	1	Specifying how many items to write into.
Fault protection	Keep latest data Clear all data bits to 0 Set to user defined value		If MGate's connection to the other side (server/slave) fails, the gateway cannot receive data, but the gateway will continuously send output data to the Modbus TCP server device. To avoid problems in this case, the MGate 5119 can be configured to react in one of the following three ways: Keep latest data, clear data to zero, set the data bits to user-defined values.
User-defined value	00 to FF (Hex)	00 00	The user-defined values to write into the data bits when the Set to user defined value option is selected.
Fault timeout	100 to 65535 ms	6000	Defines the communication timeout for the opposite side.

Protocol Settings—Modbus RTU/ASCII Master Settings

Modbus RTU/ASCII Settings

Your device : IEC 61850 Client → Role 1 of MGate 5119 : IEC 61850 Server → Role 2 of MGate 5119 : Modbus RTU/ASCII Master → Your device : Modbus RTU/ASCII Slave

Role: Master
 Mode: ASCII

Master Settings
 Initial delay: 0 (0 - 30000 ms)
 Max. retry: 3 (0 - 5)
 Response timeout: 1000 (10 - 120000 ms)

Modbus Commands
 Add Edit Clone Delete Move

Index	Name	Slave ID	Function	Address / Quantity	Trigger	Poll Interval	Endian Swap	Data Type
-------	------	----------	----------	--------------------	---------	---------------	-------------	-----------

Submit

Master Settings

Parameter	Value	Default	Description
Mode	RTU or ASCII	RTU	The Modbus protocol type
Initial delay	0 to 30000 ms	0	Some Modbus slaves may take more time to boot up than other devices. In some environments, this may cause the entire system to suffer from repeated exceptions during the initial boot-up. After booting up, you can force the MGate to wait before sending the first request with the Initial Delay setting.
Max. retry	0 to 5	3	The number of times the master will retry the same request when the response times out.
Response timeout	10 to 120000 ms	1000	According to the Modbus standard, the device manufacturer defines the time it takes for a slave device to respond to. Based on this response time, a master can be configured to wait a certain amount of time for a slave’s response. If no response is received within the specified time, the master will disregard the request and continue operation. This allows the Modbus system to continue operations even if a slave device is disconnected or faulty. On the MGate 5119, the Response timeout field is used to configure how long the gateway will wait for a response from a Modbus ASCII or RTU slave. Refer to your device manufacturer’s documentation to manually set the response time.
Inter-frame delay (only for Modbus RTU)	10 to 500 ms	0	Use this function to determine the timeout interval between characters for Modbus devices that cannot receive Rx signals within an expected time interval. If the response is timed out, all received data will be discarded. The MGate 5119 will automatically determine the timeout interval if the timeout value is set to 0.
Inter-character timeout	10 to 500 ms	0	The users can determine the time delay to transmit the data frame received from the slave device to the

Parameter	Value	Default	Description
(only for Modbus RTU)			upstream. The MGate 5119 will automatically determine the time interval if it is set to 0.

Add Modbus Commands

Refer to *Modbus TCP Client (Master) Settings*.

Protocol Settings—IEC 60870-5-104 Client Settings

⚙️ **IEC 60870-5-104 Client Setting**

Role Client

Basic Settings

COT size 1 2

Originator address (0 - 255)

Advanced Settings

k (1 - 32)

w (1 - 32)

T0 timeout (1 - 3000000 ms)

T1 timeout (1 - 3000000 ms)

T2 timeout (1 - 3000000 ms)

T3 timeout (1 - 172800000 ms)

Server List

Index	Device Name	IP Port	ASDU Address
<input type="button" value="Add"/> <input type="button" value="Edit"/> <input type="button" value="Clone"/> <input type="button" value="Delete"/> <input type="button" value="Move"/>			

Parameter	Value	Default	Description
COT size	1 to 2	1	Set the size of ASDU COT field
Originator address	0 to 255	0	The address of the IEC 60870-5-104 client
k	1 to 32	12	Maximum number of unacknowledged I format transmitted APDUs
w	1 to 32	8	Maximum number of unacknowledged I format received APDUs
T0 timeout	1 to 3000000 ms	1000	Timeout of determination if a connection has been lost with the remote server
T1 timeout	1 to 3000000 ms	15000	Timeout of waiting for acknowledgement of a transmitted APDU
T2 timeout	1 to 3000000 ms	10000	Timeout of when to send S-format to the host to acknowledge outstation messages received
T3 timeout	1 to 172800000 ms	20000	Timeout for sending a test frame to prevent from long idle state

Add IEC 60870-5-104 Server List

Server Settings

IEC 60870-5-104 Client Settings > Server Settings

Parameter	Value	Default	Description
Device name	An alphanumeric string	Device 1	You can enter a name to help you identify the unit, such as the function, etc.
IP address	IP: 0.0.0.0 to 255.255.255.255 TCP port: 1024 to 60000	0.0.0.0:2404	Shows IP address of IEC 60870-5-104 server that MGate connects to.
ASDU address	0 to 65534	1	Shows ASDU address of IEC 60870-5-104 server that MGate connects to.
Initial general interrogation	Enable/Disable	Enable	IEC 60870-5-104 client does general interrogation with server after connecting.
Cyclic general interrogation interval	0 to 86400 s; 0 for disable	600	General interrogation polling intervals.

Parameter	Value	Default	Description
Cyclic interrogation group interval	0 to 86400 s; 0 for disable	0	Interrogation group polling intervals.
Initial counter interrogation	Enable/Disable	Enable	IEC 60870-5-104 client counters interrogation with the server after connecting.
Cyclic counter interrogation interval	0 to 86400 s; 0 for disable	600	Counter interrogation polling intervals.
Cyclic interrogation counter group interval	0 to 86400 s; 0 for disable	0	Interrogation counter group polling intervals.
Timestamp reference	UTC, Local time	UTC	Command with timestamp refers to UTC or Local time.
Enable cse active termination	Enable/Disable	Enable	IEC 60870-5-104 client expects ACT TERM from slave upon completion of commands CSENA, CSENB, CSENC.
Enable cmd active termination	Enable/Disable	Enable	IEC 60870-5-104 client expects ACT TERM from slave upon completion of commands CSCNA, CDCNA, CRCNA, CBONA.
Wait termination timeout	1 to 100 s	10	The time waiting for ACT TERM from the server upon completion of all control commands.
Initial clock sync	Enable/Disable	Enable	IEC 60870-5-104 client synchronize clock of the IEC 60870-5-104 server after connecting.
Cyclic clock sync interval	0 to 86400 s; 0 for disable	600	Cyclic clock sync command polling intervals.
Endian swap	None Byte Word Byte and Word	None	Data Byte Swapping None: Don't need to swap Byte: 0x0A, 0x0B, 0x0C, 0x0D becomes 0x0B, 0x0A, 0x0D, 0x0C Word: 0x0A, 0x0B, 0x0C, 0x0D becomes 0x0C, 0x0D, 0x0A, 0x0B Byte and Word: 0x0A, 0x0B, 0x0C, 0x0D becomes 0x0D, 0x0C, 0x0B, 0x0A.
Select/Execute mode	Select/Execute, Execute Only	Select/Execute	Select/Execute: Writes occur with a dual command/response from the device. Execute Only: Writes occur with a single command/response from the device.

When connecting to an IEC 60870-5-104 server, you must add the objects you want to collect and configure them.

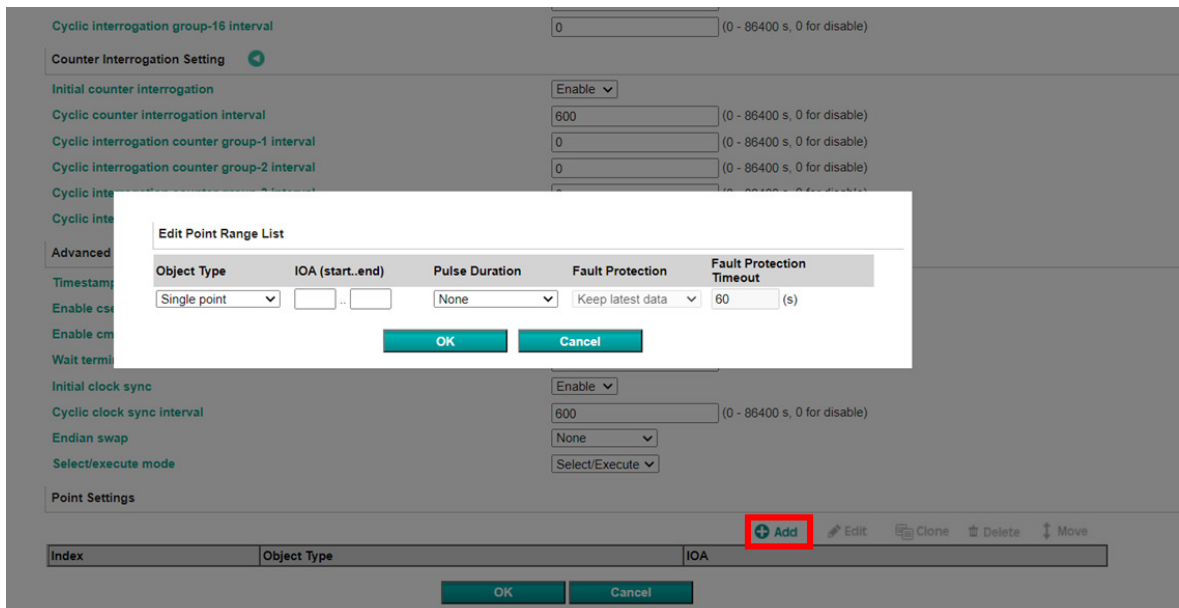

Parameter	Value	Default	Description
Object Type	Single point, Double point, Step position, Bitstring of 32 bit, Measured value (Normalized), Measured value (Scaled), Measured value (Floating), Integrated totals	Single point	The server object that the MGate would like to collect.
IOA (start...end)	1 to 16777215	-	Set a range of IOA. The maximum number of points in each point range list is up to 255.
Pulse Duration	None, Short Pulse, Long Pulse, Persistent Output	None	-
Fault Protection	Keep latest data Clear all data bits to 0 Set to user defined value	Keep latest data	If the MGate's connection to the other side (server/slave) fails, the gateway cannot receive data, but the gateway will continuously send output data to the Modbus TCP server device. To avoid problems in this case, the MGate 5119 can be configured to react in one of the following three ways: Keep latest data, clear data to zero, set the data bits to user-defined values.

Parameter	Value	Default	Description
User-defined Value	Single point: Off/On Double point: Intermediate/Off/On/ Indeterminate Step position: 0 to 255 Bitstring of 32 bit: 0000 to FFFF Measured value (Normalized): 0000 to FFFF Measured value (Scaled): 0 to 32767 Measured value (Floating): 0.001 to 9999999	Single point: Off Double point: Intermediate Step position: 0 Bitstring of 32 bit: 0 Measured value (Normalized): 0 Measured value (Scaled): 0 Measured value (Floating): 0	The user-defined values applicable for the data bits when the Set to user defined value option is selected.
Fault Protection Timeout	1 to 86400 s	60s	Defines the communication timeout for the opposite side.

Protocol Settings—IEC 60870-5-101 Master Settings

You can configure parameters related to the IEC 60870-5-101 communication.

IEC 60870-5-101 Master Setting

Parameter	Value	Default	Description
Link mode	Unbalanced Transmission/ Balanced Transmission	Unbalanced Transmission	The transmission ways of the IEC 60870-5-101 protocol.
Link address size	1 to 2	2	Set the size of the Link address field specified in Link transactions for the relevant slave session.
ASDU size	1 to 2	2	Set the size of the ASDU address field for the relevant slave session.
COT size	1 to 2	1	Set the size of ASDU COT field.
IOA size	1 to 3	2	Set the size of the IOA address field for the relevant slave session.

Parameter	Value	Default	Description
Originator address	0 to 255	0	The address of the IEC 60870-5-101 master.
Frame timeout	1 to 2073600000 ms	15000	Timeout for the serial port to decide whether or not a frame is completely received.
Link confirm mode	Always/Never	Always	Always: Mode for master to use SEND-CONFIRM frame. Never: SEND-NO REPLY frame(Never) to send user data.
Link layer retries	0 to 255	3	The number of retries when the link confirms timeout.
Offline poll period	1 to 2073600 s	10	Time for the master to wait before resending the request status of the link to the slave after Trp timeout.

After basic and advanced settings, you must configure the slave lists of the MGate you would like to connect to.

Slave Settings

IEC 60870-5-101 Master Settings > Slave Settings

Basic Settings

Device name:

Link address: (0 - 65534)

ASDU address: (1 - 65534)

General Interrogation Setting

Initial general interrogation: (0 - 86400 s, 0 for disable)

Cyclic general interrogation interval: (0 - 86400 s, 0 for disable)

Cyclic interrogation group-1 interval: (0 - 86400 s, 0 for disable)

Cyclic interrogation group-2 interval: (0 - 86400 s, 0 for disable)

Cyclic interrogation group-3 interval: (0 - 86400 s, 0 for disable)

Cyclic interrogation group-4 interval: (0 - 86400 s, 0 for disable)

Cyclic interrogation group-5 interval: (0 - 86400 s, 0 for disable)

Cyclic interrogation group-6 interval: (0 - 86400 s, 0 for disable)

Cyclic interrogation group-7 interval: (0 - 86400 s, 0 for disable)

Cyclic interrogation group-8 interval: (0 - 86400 s, 0 for disable)

Cyclic interrogation group-9 interval: (0 - 86400 s, 0 for disable)

Cyclic interrogation group-10 interval: (0 - 86400 s, 0 for disable)

Cyclic interrogation group-11 interval: (0 - 86400 s, 0 for disable)

Cyclic interrogation group-12 interval: (0 - 86400 s, 0 for disable)

Cyclic interrogation group-13 interval: (0 - 86400 s, 0 for disable)

Cyclic interrogation group-14 interval: (0 - 86400 s, 0 for disable)

Cyclic interrogation group-15 interval: (0 - 86400 s, 0 for disable)

Cyclic interrogation group-16 interval: (0 - 86400 s, 0 for disable)

Counter Interrogation Setting

Initial counter interrogation: (0 - 86400 s, 0 for disable)

Cyclic counter interrogation interval: (0 - 86400 s, 0 for disable)

Cyclic interrogation counter group-1 interval: (0 - 86400 s, 0 for disable)

Cyclic interrogation counter group-2 interval: (0 - 86400 s, 0 for disable)

Cyclic interrogation counter group-3 interval: (0 - 86400 s, 0 for disable)

Cyclic interrogation counter group-4 interval: (0 - 86400 s, 0 for disable)

Advanced Settings - Link Layer

Link confirm timeout: (1 - 2073600000 ms)

Class 1 poll delay: (0 - 2073600000 ms, 0 for disable)

Class 2 poll delay: (0 - 2073600000 ms, 0 for disable)

Advanced Settings - Application Layer 

Timestamp reference UTC ▼

Enable cse active termination Enable ▼

Enable cmd active termination Enable ▼

Wait terminate timeout 10 (1 - 100 s)

Initial clock sync Enable ▼

Cyclic clock sync interval 600 (0 - 86400 s, 0 for disable)

Endian Swap Byte ▼

Select/Execute Mode Select/Execute ▼

Point Settings  Add

Index	Memory Access	Object Type	IOA
<div style="display: flex; justify-content: center; gap: 10px;"> Ok Cancel </div>			

Parameter	Value	Default	Description
Device name	An alphanumeric string	Device 1	You can enter a name to help you identify the unit, such as the function, etc.
Link address	0 to 65534	3	Shows link address of IEC 60870-5-101 slave that the MGate connects to.
ASDU address	0 to 65534	3	Shows ASDU address of IEC 60870-5-101 slave that the MGate connects to.
Initial general interrogation	Enable/Disable	Enable	IEC 60870-5-101 master does general interrogation with slave or not.
Cyclic general interrogation interval	0 to 86400s, 0 for disable	600	Cyclic general interrogation command polling time to IEC 60870-5-101 slave.
Cyclic interrogation group interval	0 to 86400s, 0 for disable	0	Cyclic interrogation group command polling time to IEC 60870-5-101 slave.
Initial counter interrogation	Enable/Disable	Enable	IEC 60870-5-101 master counters interrogation with slave.
Cyclic counter interrogation interval	0 to 86400s, 0 for disable	600	Cyclic counter interrogation command polling time to IEC 60870-5-101 slave.
Cyclic interrogation counter group interval	0 to 86400s, 0 for disable	0	Cyclic interrogation counter polling time to IEC 60870-5-101 slave.
Link confirm timeout	1 to 2073600000 ms	2000	Timeout for repetition of frames in IECIEC 60870-5-101 data link layer(T0).
Class 1 poll delay	0 to 2073600000 ms, 0 for disable	0	Set the minimum milliseconds to delay between Class 1 polls for pending data.
Class 2 poll delay	0 to 2073600000 ms, 0 for disable	500	Set the minimum milliseconds to delay between Class 2 polls for pending data.
Timestamp reference	Local time	UTC	Command with timestamp references to UTC or Local time.
Enable cse active termination	Enable/Disable	Enable	IEC 60870-5-101 master expects ACT TERM from slave upon completion of commands CSENA, CSENB, CSENC.
Enable cmd active termination	Enable/Disable	Enable	IEC 60870-5-101 master expects ACT TERM from slave upon completion of commands CSCNA, CDCNA, CRCNA, CBONA.

Parameter	Value	Default	Description
Wait terminate timeout	1 to 100 s	10	The time waiting for ACT TERM from the slave upon completion of all control commands.
Initial clock sync	Enable/Disable	Enable	IEC 60870-5-101 master synchronize clock of IEC 60870-5-101 slave or not.
Cyclic clock sync interval	0-86400s, 0 for disable	600	Cyclic clock sync command polling time to IEC 60870-5-101 slave.
Endian swap	None Byte Word Byte and Word	Byte	Data Byte Swapping None: Don't need to swap Byte: 0x0A, 0x0B, 0x0C, 0x0D becomes 0x0B, 0x0A, 0x0D, 0x0C Word: 0x0A, 0x0B, 0x0C, 0x0D becomes 0x0C, 0x0D, 0x0A, 0x0B. Byte and Word: 0x0A, 0x0B, 0x0C, 0x0D becomes 0x0D, 0x0C, 0x0B, 0x0A.
Select/Execute mode	Select/Execute, Execute Only	Select/Execute	Select/Execute: Writes occur with a dual command/response from the device. Execute Only: Writes occur with a single command/response from the device.

When the MGate functions as an IEC 60870-5-101 master, you must create space to collect the data from IEC 60870-5-101 slave device. Define the points in the range with different object types.

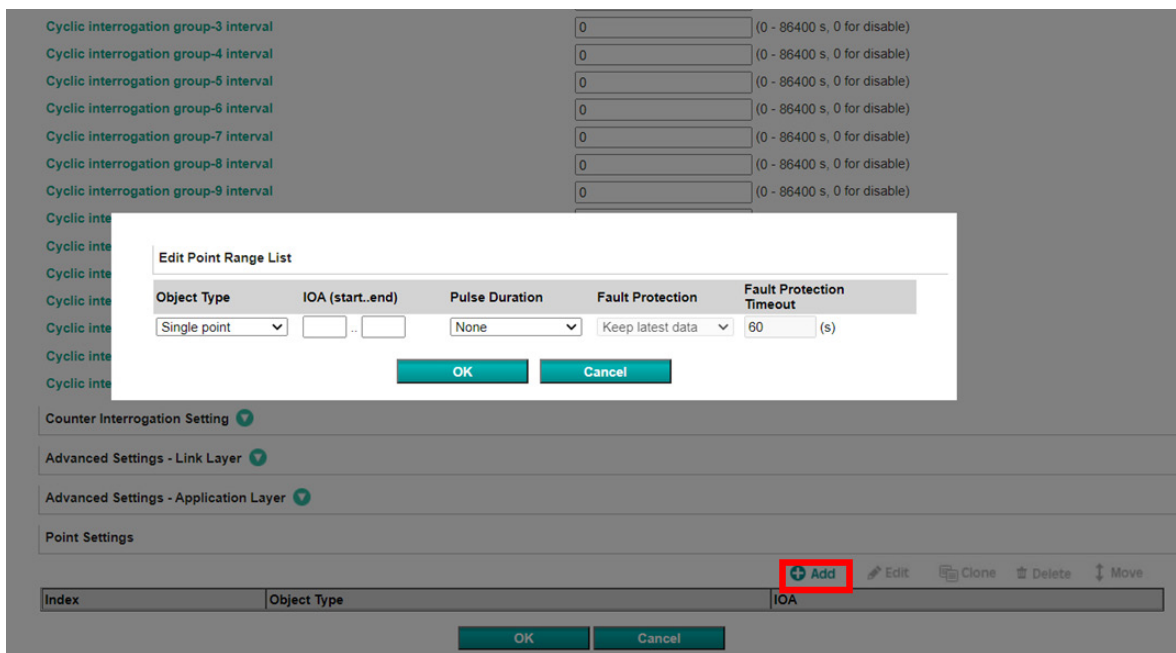

Parameter	Value	Default	Description
Object Type	Single point, Double point, Step position, Bitstring of 32 bit, Measured value (Normalized), Measured value (Scaled), Measured value (Floating), Integrated totals	Single point	The server object the MGate would like to collect.

Parameter	Value	Default	Description
IOA(start...end)	1 to 16777215	-	Set a range of IOA. The maximum number of points in each point range list is up to 255.
Pulse Duration	None, Short Pulse, Long Pulse, Persistent Output	None	-
Fault Protection	Keep latest data Clear all data bits to 0 Set to user defined value	Keep latest data	If MGate's connection to the other side (server/slave) fails, the gateway cannot receive data, but the gateway will continuously send output data to the Modbus TCP server device. To avoid problems in this case, configure the MGate 5119 to react in one of the following three ways: Keep latest data, clear data to zero, set the data bits to user-defined values.
User-defined Value	Single point: Off/On Double point: Intermediate/Off/On/ Indeterminate Step position: 0 to 255 Bitstring of 32 bit: 0000 to FFFF Measured value (Normalized): 0000 to FFFF Measured value (Scaled): 0 to 32767 Measured value (Floating): 0.001 to 9999999	Single point: Off Double point: Intermediate Step position: 0 Bitstring of 32 bit: 0 Measured value (Normalized): 0 Measured value (Scaled): 0 Measured value (Floating): 0	The user-defined values applicable for the data bits when the Set to user defined value option is selected.
Fault Protection Timeout	1 to 16777215s	60s	Defines the communication timeout for the opposite side.

Protocol Settings—DNP3 TCP/UDP Master Settings

Configuration of a DNP3 TCP/UDP master comprises two parts: **Master settings** and **Outstation List**. The **Master settings** specify the MGate's Master address and connection type with the outstation. The **Outstation List** is a list of all the outstations that the MGate connects to.

⚙️ DNP3 TCP/UDP Master Settings

Master Settings

Parameter	Value	Default	Description
DNP3 master address	0 to 65519	1	DNP3 master address.
Network Type	TCP UDP	TCP	Network type.

After configuring the **Master Settings**, click on **Add** in the **Outstation List** section.

⚙️ DNP3 TCP/UDP Master Settings

NOTE When the MGate acts as a DNP3 TCP/UDP master, the TCP/UDP port is fixed at 20000.

Adding an Entry to the Outstation List (Outstation Settings)

Click on **Add** option to open the **Outstation Settings** page, which comprises three sections: **Basic Settings, Advanced Settings, Security Settings,** and **DNP3 Object Settings.**

Outstation Settings

DNP3 TCP/UDP Master Settings > Outstation Settings

Basic Settings

Name:

IP address: port

DNP3 data link address: (0-65519)

Unsolicited message:

Polling all class 0 static points: (100 - 600000ms)

Polling class 1 event: (100 - 600000ms)

Polling class 2 event: (100 - 600000ms)

Polling class 3 event: (100 - 600000ms)

Advanced Settings

Security Settings

DNP3 Object Settings

[Add](#) [Edit](#) [Delete](#)

index	Object Type	Point Index

Basic Settings

Outstation Settings

DNP3 TCP/UDP Master Settings > Outstation Settings

Basic Settings

Name:

IP address: port

DNP3 data link address: (0-65519)

Unsolicited message:

Polling all class 0 static points: (100 - 600000ms)

Polling class 1 event: (100 - 600000ms)

Polling class 2 event: (100 - 600000ms)

Polling class 3 event: (100 - 600000ms)

Parameter	Value	Default	Description
Name	an alphanumeric string	Outstation	Max. 32 characters
IP address	0.0.0.0 to 255.255.255.255	0.0.0.0	The IP addresses of a remote slave device.
Port	1 to 65535	20000	The TCP port number of a remote slave device.
DNP3 data link address	0 to 65519	4	DNP3 ID/Outstation address
Unsolicited message	Enable Disable	Disable	Enables to accept outstation's unsolicited responses.
Polling all class 0 static points	None At start up only Cyclic (100 to 600000 ms)	Cyclic (10000 ms)	The method to poll point's current value.
Polling class 1 event	None At start up only Cyclic (100 to 600000 ms)	Cyclic (5000 ms)	The method to poll class-1 events.

Parameter	Value	Default	Description
Polling class 2 event	None At start up only Cyclic (100 to 600000 ms)	Cyclic (5000 ms)	The method to poll class-2 events.
Polling class 3 event	None At start up only Cyclic (100 to 600000 ms)	Cyclic (5000 ms)	The method to poll class-3 events.

Advanced Settings

Advanced Settings 

Data link confirm mode	<input type="text" value="Disable"/>
Data link confirm timeout	<input type="text" value="2000"/> (0 - 65535ms)
Data link max retry	<input type="text" value="1"/> (0 - 5)
Application response timeout	<input type="text" value="10000"/> (0 - 65535ms)
Auto time sync	<input type="text" value="Disable"/>
Freeze function code	<input type="text" value="7:Freeze"/>

Parameter	Value	Default	Description
Data link confirm mode	Enable Disable	Disable	This value specifies whether data link frames sent to the remote device require a data link confirmation. This parameter should be set to Disable for almost all applications.
Data link confirm timeout	0 to 65535 ms	2000	This parameter specifies the required time for a data link confirmation from the remote device before a retry is attempted.
Data link max retry	0 to 5	1	The maximum number of retries at the Data Link level to get a confirmation. If this value is set to 0, retries are disabled at the data link level of the protocol. This parameter is only used when the frame is sent and a confirmation is requested.
Application response timeout	0 to 65535 ms	10000	During the timeout period, the master will wait for each response message. If Data link confirm mode is enabled, make sure the timeout period is set long enough to permit data link retries.
Auto time sync	Enable Disable	Disable	When an outstation expects that its timing reference (such as a crystal oscillator) will drift beyond the required accuracy, it should set the IIN1.4 [NEED_TIME] bit in responses. The master must send the time promptly after receiving a response with this bit set when enabling Auto Time Sync. Outstations that set the IIN1.4 [NEED_TIME] bit at unreasonably short intervals will hurt system operation by dedicating a disproportionate amount of processing to non-data collection activities.

Freeze Function Code (options 7, 8, 9, and 10)

This function copies the value of the current point of an outstation counter to a second and separate memory location associated with the same point. The copied value is referred to as the frozen value and remains constant until the next freeze operation for the same point of the outstation counter is performed.

Parameters	Value	Description
Default freeze function	7: Freeze (Default)	Sends the IMMED_FREEZE function code to the outstation. Result: A null response from the outstation.
	8: Freeze No Ack	Sends the IMMED_FREEZE_NR function code to the outstation. This function code is recommended for broadcast freezing. Result: No response from the outstation.
	9: Freeze Clear	Sends the IMMED_FREEZE function code to the outstation. Result: The current value of the outstation counter is immediately reset to 0 and a null response is received from the outstation.
	10: Freeze Clear No Ack	Sends IMMED_FREEZE_NR function code to the outstation. Result: The current value of the outstation counter is immediately set to 0 and no response is received from the outstation.

Security Settings

Security Settings

Enable secure authentication

Enable aggressive mode

Authentication update key
(16 octets for AES128 Key Wrap Algorithm, 32 octets for AES256)

Max session key change count (0 - 10000, 0 is disable)

Session key change interval (0 - 7200 secs, 0 is disable)

Authentication response timeout (1 - 65535 secs)

Parameters	Value	Default	Description
Enable secure authentication	Disable/SAv5	Disable	DNP3 secure authentication will be enabled when selecting SAV5.
Enable aggressive mode	Enable/Disable	Enable	Compared to the full 'Challenge-Response' mechanism, aggressive mode is with great communication efficiency.
Authenticate updated key	16 octets or 32 octets		Updated keys can be entered as either 32 or 16 characters.
Max. session key change count	0 to 10000, 0 is disable	1000	The number of transmitted authentication messages that the DNP3 master changes session keys.
Session key change interval	0 to 7200 secs, 0 is disable	900	The timeout used by the DNP3 master to determine when to change session keys.
Authentication response timeout	1 to 65535 secs	2	The parameter specifies how long the MGate waits for an authentication response.

DNP3 Object Setting

In this section you can click **Add** to configure **Points Index** for each DNP3 object. The MGate supports **Binary Input, Binary Output, Counter, Analog Input, and Analog Output** object type. Be sure to include a reference to your DNP3 outstation device here. The MGate uses the information in this section to determine how to exchange data with a DNP3 outstation.

Binary Input

You can input the **Point index** range. Configure the range of **Point index** between 0 to 65535. The maximum number of points in each point range list is up to 255.

Add Point Range List

Object type Binary Input ▼

Point index (start...end) 0 ... 0

OKCancel

Binary Output

You can input the **Point index** range. Configure the range of **Point index** between 0 to 65535. The maximum number of points in each point range list is up to 255.

Edit Point Range List

Object type Binary Output ▼

Point index (start...end) 0 ... 10

Default CROB parameter

Index	Function code	Control models	Cycle count	on time(ms)	off time(ms)	Fault protection type	Fault protection timeout(sec)
0	3/4 Select-Operate ▼	Latch on-off model ▼				Keep latest data ▼	6000 (1 - 86400s)
1	3/4 Select-Operate ▼	Latch on-off model ▼				Keep latest data ▼	6000 (1 - 86400s)
2	3/4 Select-Operate ▼	Latch on-off model ▼				Keep latest data ▼	6000 (1 - 86400s)
3	3/4 Select-Operate ▼	Latch on-off model ▼				Keep latest data ▼	6000 (1 - 86400s)
4	3/4 Select-Operate ▼	Latch on-off model ▼				Keep latest data ▼	6000 (1 - 86400s)
5	3/4 Select-Operate ▼	Latch on-off model ▼				Keep latest data ▼	6000 (1 - 86400s)
6	3/4 Select-Operate ▼	Latch on-off model ▼				Keep latest data ▼	6000 (1 - 86400s)
7	3/4 Select-Operate ▼	Latch on-off model ▼				Keep latest data ▼	6000 (1 - 86400s)
8	3/4 Select-Operate ▼	Latch on-off model ▼				Keep latest data ▼	6000 (1 - 86400s)

OKCancel

Parameter	Value	Default	Description
Function code	3/4: Select-Operate 5: Direct Operate 6: Direct Operate, No Ack	3/4: Select-Operate	The method of CROB (Control Relay Output Blocks) control request.
Control models	Latch on-off model Close-trip model Activation model	Latch on-off model	Regarding control models, refer to DNP3 device attributes.
Object count	0 to 65535	1	The count number of pulse on/off, with on time and off time for close-trip models and activation models.
On time (ms)	0 to 4294967295	100	Pulse on time.
Off time (ms)	0-to 4294967295	100	Pulse off time.
Fault protection type	Keep latest data On Off Close Trip	Keep latest data	When the communication on the opposite side stops, users can select a protection method to write a CROB request to the end device.
Fault protection timeout (sec)	1 to 86400 second	60000	Defines the communication timeout for the opposite side.

Counter Settings

You can input the **Point index** range. Configure the range of **Point index** between 0 to 65535. The maximum number of points in each point range list is up to 255.

Add Point Range List

Object type Counter ▾

Point index (start...end) 0 ... 0

OK Cancel

Analog Input

You can input the **Point index** range. Configure the range of **Point index** between 0 to 65535. The maximum number of points in each point range list is up to 255.

Add Point Range List

Object type Analog Input ▾

Point index (start...end) 0 ... 0

OK Cancel

Analog Output

You can input the **Point index** range. Configure the range of **Point index** c between 0 to 65535. The maximum number of points in each point range list is up to 255.

Add Point Range List

Object type Analog Output ▾

Point index (start...end) 0 ... 5

Default Analog Output parameter

Index	Variation	Function code	Fault protection type	Fault protection timeout(sec)
0	2:16-Bit ▾	3/4:Select-Operate ▾	Keep latest data ▾	6000 (1 - 86400s)
1	2:16-Bit ▾	3/4:Select-Operate ▾	Keep latest data ▾	6000 (1 - 86400s)
2	2:16-Bit ▾	3/4:Select-Operate ▾	Keep latest data ▾	6000 (1 - 86400s)
3	2:16-Bit ▾	3/4:Select-Operate ▾	Keep latest data ▾	6000 (1 - 86400s)
4	2:16-Bit ▾	3/4:Select-Operate ▾	Keep latest data ▾	6000 (1 - 86400s)
5	2:16-Bit ▾	3/4:Select-Operate ▾	Keep latest data ▾	6000 (1 - 86400s)

OK Cancel

Parameter	Value	Default	Description
Variation	1: 32-bit 2: 16-bit 3: Single-Precision, Float-Point	2: 16-bit	The format of the object.
Function code	3/4: Select-Operate 5: Direct Operate 6: Direct Operate, No Ack	3/4: Select-Operate	The method for CROB (Control Relay Output Blocks) control request.
Fault protection type	Keep latest data Clear data to zero User-defined value	Keep latest data	When the communication on the opposite side stops, users can select a protection method to write a CROB request to the end device.
Fault protection timeout (sec)	1 to 86400 second	60000	Defines the communication timeout for the opposite side.

Protocol Settings—DNP3 Serial Master Settings

DNP3 Serial Master Settings

Master Settings

DNP3 master address: (0-65519)

Outstation List

Index	Name	DNP3 Address	Binary Input Points	Binary Output Points	Counter Points	Analog Input Points	Analog Output Points
<input type="button" value="Submit"/>							

Master Settings

Parameter	Value	Default	Description
DNP3 master address	0 to 65519	1	DNP3 master address.

Outstation List

Refer to *Protocol Settings—DNP3 TCP/UDP Master Settings* section.

Protocol Settings—IEC 61850 Server Settings

Connection parameters	
Non-security TCP port	102
Security TCP port	3782
OSI ACSE AP title	1,3,9999,23
OSI ACSE AE qualifier	23
OSI presentation selector	00 00 00 01
OSI session selector	00 01
OSI transport selector	00 01

SCL Source

The MGate as an IEC 61850 server should have its own substation configuration language (SCL) file, which can be imported or created by the MGate itself. If you have created a SCL file for the MGate, you can select **SCL file import** and click the **Import** button to import the SCL file.

SCL Source

SCL file options

SCL file

SCL file import Local SCL file generator

mgate_import_default.cid

Typically, the SCL file is generated by a third party tool. This can increase costs and be time-consuming. To overcome this pain point, the MGate has a built-in SCL generator, which can easily generate SCL files through the web console. You can select **Local SCL file generator** and click the **Create & Edit** button to create the SCL file.

SCL Source

SCL file options

SCL file import Local SCL file generator

NOTE Changing the SCL file options will reset the mapping list.

SCL Source – Basic Settings

First, we should configure **Basic Setting** for the SCL file, which should include **Header ID**, **IED Name**, **Access point name**, **Logical device name**, and **Subnetwork name**.

Basic Setting

Header ID:

IED name:

Access point name:

Logical device name:

Subnetwork name:

SCL Source – Logical Node

Second, we should create **Logical Node** by clicking **Add** button. Then, the setting page will pop up and you can add the logical nodes.

Logical Node

Class	Instance	Type
LLN0		LLN01
LPHD	1	LPHD1

For example, if you want to create a logical node to monitor power quality, you can select the **Class** as **MMXU-Measurement (three-phase)**, input the **Start instance number**, and **Instance count**, choose what objects you want to create (here showing TotW, Hz, A), then click **OK**. You will see the logical node of MMXU has been listed in the table. If you want to copy the logical node with objects, you can select **Existing logical node type duplication**.

NOTE The maximum number of **Start instance** and **Instance count** is 100

Add Logical Node

Class:

Start instance number:

Instance count:

New logical node type
 Existing logical node type duplication

MMXU1

- TotW
- TotVAr
- TotVA
- TotPF
- Hz
- PPV
- PhV
- A

Logical Node

[+ Add](#) [Edit](#) [Delete](#)

Class	Instance	Type
LLNO		LLNO1
LPHD	1	LPHD1
MMXU	1	MMXU1

Under the **Local SCL file generator** function, we list the current logical nodes that we support below:

Supported Logical Nodes	Default Objects	Supported Objects
CSWI – Switch controller	Beh, Mod, Pos	Beh, Mod, Pos
GGIO – Generic process I/O	Beh, Mod, EEHealth	Beh, Mod, EEHealth, Ind, AnIn, AnOut, SPCSO, DPCSO, ISCSO
MHAI – Harmonics or interharmonics	Beh, Mod	Beh, Mod, Hz, HA, HPhv, HPPV, HKf, ThdA, ThdOddA, ThdEvnA, ThdPhV, ThdOddPhV, ThdPPV, ThdOddPPV, ThdEvnPPV, HCfA
MMTR – Metering (three-phase)	Beh, Mod	Beh, Mod, TotAh, TotWh, TotVArh, SupWh, SupVArh, DmdWh, DmdVArh
MMXU – Measurement (three-phase)	Beh, Mod	Beh, Mod, TotW, TotVAr, TotVA, TotPF, Hz, PPV, PhV, A, W, Var, VA, PF
MSQI – Sequence and imbalance	Beh, Mod, SeqA, SeqV	Beh, Mod, SeqA, SeqV
XCBR – Circuit breaker	Beh, Mod, Loc, OpCnt, Pos, BlkOpn, BlkCls	Beh, Mod, Loc, OpCnt, Pos, BlkOpn, BlkCls
XSWI – Circuit switch	Beh, Mod, Loc, OpCnt, SwTyp, Pos, BlkOpn, BlkCls	Beh, Mod, Loc, OpCnt, SwTyp, Pos, BlkOpn, BlkCls

SCL Source – Dataset

You can click the **Add** button and go to **Add Dataset** page. You should input the **Dataset Name** and **Description**, choose the **Logical node class** and **Logical node instance** that have been created. Then, select the **Data Tags** you want to add to the FCDA (functionally constrained data attribute) list.

Dataset

[+ Add](#) [Edit](#) [Delete](#)

Dataset Name	Description
--------------	-------------

Add Dataset

Dataset name
Description
Logical node class
Logical node instance

Data Tags

- + LN LPHD1
- LN MMXU1
- + FC ST
- + FC CF
- FC MX
- + DO TotW
- + DO TotVAr**
- DO TotVA

FCDA List

- MMXU1\$MX\$TotVA
- MMXU1\$MX\$TotW

→

SCL Source – Report Control

You can configure **Report Control** by clicking the **Add** button, and then the setting page will pop up.

Report Control

+ Add
 ✎ Edit
🗑 Delete

Report Control Block Name	Data Set	Report ID	Buffered Type
---------------------------	----------	-----------	---------------

Add Report

Report name:

Description:

Logical node class:

Logical node instance:

Configuration revision:

Report ID:

Dataset name:

Buffered:

Integrity period: (ms)

Buffer time: (ms)

Trigger Options

Enable

Data Change Quality Change Period

Optional Fields

Sequence Number Time Stamp Dataset Reason Code

Data Attribute Reference Entry ID Configuration Revision

Report Enabled

Number of clients:

Ok
Cancel

Parameters for Add Report Control:

Parameter	Value	Description
Report control name	(an alphanumeric string)	The name of the report control block. Max. 40 characters.
Description	(an alphanumeric string)	The description of the report control block. Max. 40 characters.
Logical node class	One type of logical node	Choose the logical node that has been created.
Logical instance	One of instance number	The instance number of the chosen logical node.
Configuration revision	1 to 9999	The revision of the report control block.
Report ID	(an alphanumeric string)	The ID to identify the report control block. Max. 40 characters.
Dataset	One of defined datasets	Members of this data set will receive a report whenever the configured events occur.
Buffer	True/False	True: the events will be buffered when the IEC 61850 connection is disconnected. False: the events will NOT be buffered when the IEC 61850 connection is disconnected.
Integrity period	1000 to 99999999 (ms)	An interval for the periodic sending of integrity reports.
Buffer time	1 to 3600000 (ms)	An interval of the buffer time when the event is triggered. In case of an event that causes a report, the IEC 61850 server will wait out the buffer time for other events. Because of this time span, all events will be reported in a single report. Note: The buffer space is up to 10 KB.

Parameters of Trigger Options:

Trigger Options	Description
Data change	If enabled, the MGate will send reports to the client when the value is changed.
Quality change	If enabled, the MGate will send reports to the client when the quality is changed.
Period	If enabled, the MGate will send periodic integrity reports to the client.

Parameters of Optional Fields:

Optional Fields	Description
Sequence number	If enabled, the sequence number will be included in the report.
Time stamp	If enabled, the time stamp will be included in the report.
Dataset	If enabled, the name of the dataset will be sent in this report.
Reason code	The reason codes show each reported value; the reason it was reported. If enabled, the reason code will be included in the report.
Data attribute reference	If enabled, the references of the reported data set members will be included in the report.
Entry ID	If enabled, the entry identification will be included in the report.
Configuration revision	If enabled, the revision, which is equal to the configuration revision of the corresponding report control block, will be included in the report.

Parameters for the Enabled Report:

Optional Fields	Description
Number of clients	The number of clients that can access the report. The range is from 1 to 99.

SCL Data and Mapping list

After importing the SCL file or creating SCL with the MGate’s built-in tool, the **Data Objects (from IEC 61850)** will show imported SCL information such as LD (Logic Node), DA (Data Attribute), and so on.

Tag List (from Modbus, DNP3, IEC101/104) shows all the tags generated from the Modbus, DNP3, IEC 60870-5-101/104 settings.

Next, do data mapping. The steps are as follows:

1. Select one object under **Data Objects (from IEC 61850)**
2. Select one tag under **Tag List (from Modbus, DNP3, IEC101/104)**
3. Press **Data Mapping** under the table
4. The mapping results will appear in **Mapping List**.

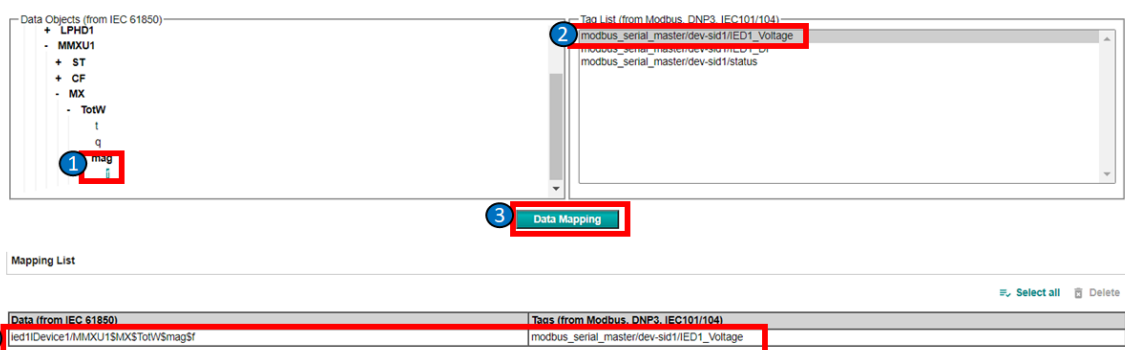

Tag List from DNP3

When we create a DNP3 outstation, the tag list will automatically generate three new tags. They are frozen counter, freeze, and coldstart. If you want to execute the commands, you can map them to IEC 61850 data objects. Then, you can control the DNP3 outstation field device by IEC 61850 client system.

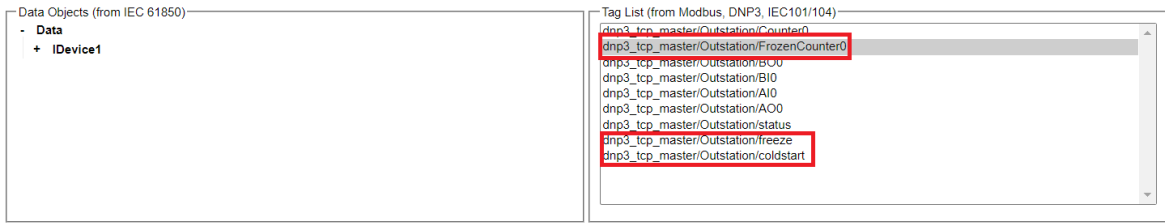

Tag Name	Data Type	Description
Freeze	INT16	If the value is set as 1, the DNP3 master will send a freeze command to the DNP3 outstation. Then, you can send a read command to get the value from Frozen Counter.
Coldstart	INT16	If the value is set as 1, the DNP3 master will send a coldstart command to the DNP3 outstation.

Timestamp Mapping Mechanism

Timestamp is critical information in the power system. Here, we describe the mechanism on how to provide/map timestamp to IEC 61850.

- 1. The tag from Modbus:** The timestamp followed by the MGate system time will be added when receiving the data. If the data is not changed, the timestamp will not be updated. Then, the timestamp will be automatically mapped to the tag from IEC 61850.
- 2. The tag from DNP3, IEC 60870-5-101, IEC 60870-5-104 without a timestamp:** The timestamp followed by the MGate system time will be added when receiving the data. If the value is not changed, the timestamp will not be updated. Then, the timestamp will be automatically mapped to the tag from IEC 61850.
- 3. The tag from DNP3, IEC 60870-5-101, IEC 60870-5-104 with a timestamp:** The timestamp will use the original timestamp from the slave device. Then, the timestamp will be automatically mapped to the tag from IEC 61850.

Device Status Monitoring

When we create southbound device settings, each device has its own status that is used to monitor device communication status. You can map status to the IEC 61850, then you can monitor the southbound device status in IEC 61850 client. Once the MGate detects response timeout or that the connection has been disconnected, the device status will turn to invalid (0). Instead, for other conditions, the device status will be valid (1).

NOTE The maximum number for data mapping is 1200.

Clients and Certificate Authorization

In this field, fill in essential information to identify the client system. The parameters of **Name** and **IP address** are required. If there is more than one IEC 61850 client system, you can click the **Add** icon at the right upper corner for more clients.

IEC 61850 Client Settings + Add

Name	<input type="text" value="Josh_PC"/>	⊘
IP address	<input type="text" value="192.168.127.1"/>	
<input checked="" type="checkbox"/> Encryption (SSL)	No file chosen	<input type="button" value="Import"/> <input type="button" value="Delete"/>
<input checked="" type="checkbox"/> Authentication Certificate		

Certificate Authorization

CA certificate	No file chosen	<input type="button" value="Import"/> <input type="button" value="Delete"/>
Server certificate	No file chosen	<input type="button" value="Import"/> <input type="button" value="Delete"/>

Parameter	Value	Description
Name	(an alphanumeric string)	Give a name for the IEC 61850 client system.
IP address	192.168.127.254 (or other 32-bit number)	The IP (Internet Protocol) address of the EC 61850 client system.

The MGate 5119 also supports a secure IEC 61850 connection. You can upload the related certificates.

Parameter	Description
Encryption (SSL)	To encrypt IEC 61850 MMS communication.
Authentication certificate	To identify whether the certificate from the IEC 61850 client is whitelisted.
CA certificate	To authenticate signatures in SSL and MAC (MMS Application Certificate).
Server certificate	The MGate’s certificate used in establishing SSL connections and authentication.

System Management

System Management—Accessible IP List

Accessible IP List

- Activate the accessible IP list (Protocol communications are NOT allowed for the IPs NOT on the list)
- Apply additional restrictions (All device services are NOT allowed for the IPs NOT on the list)

No.	Active	IP	Netmask
1	<input type="checkbox"/>	<input type="text"/>	<input type="text"/>
2	<input type="checkbox"/>	<input type="text"/>	<input type="text"/>
3	<input type="checkbox"/>	<input type="text"/>	<input type="text"/>
4	<input type="checkbox"/>	<input type="text"/>	<input type="text"/>
5	<input type="checkbox"/>	<input type="text"/>	<input type="text"/>
6	<input type="checkbox"/>	<input type="text"/>	<input type="text"/>
7	<input type="checkbox"/>	<input type="text"/>	<input type="text"/>
8	<input type="checkbox"/>	<input type="text"/>	<input type="text"/>

These settings are used to restrict access to the module by the IP address. Only IP addresses on the list will be allowed access to the device. The restriction difference listed as below table: (check box “Apply additional restrictions” only can be activated if “Active the accessible IP list” is activated).

Active the accessible IP list	Apply additional restrictions	IPs on the list (Active checked)	IPs NOT on the list (Active NOT checked)
✓		All protocol communication and services* are allowed.	Protocol communication is not allowed, but services* are still allowed.
✓	✓	All protocol communication and services* are allowed.	All services* are not allowed.

*Services shows HTTP, HTTPS, TELNET, SSL, SNMP, SMTP, DNS, NTP, DSU (Device Search Utility)

You may add a specific address or range of addresses by using a combination of an IP address and a netmask as follows:

To allow access to a specific IP address: Enter the IP address in the corresponding field; enter 255.255.255.255 for the netmask.

To allow access to hosts on a specific subnet: For both the IP address and netmask, use 0 for the last digit (e.g., "192.168.1.0" and "255.255.255.0").

To allow access to all IP addresses: Make sure that Enable the accessible IP list is not checked. These settings are used to restrict access to the module by the IP address. Only IP addresses on the list will be allowed access to the device. You may add a specific address or range of addresses by using a combination of an IP address and a netmask as follows:

Additional configuration examples are shown in the following table:

Allowed hosts	Entered IP address/Netmask
Any host	Disable "Accessible IP List" function
192.168.1.120	192.168.1.120 / 255.255.255.255
192.168.1.1 to 192.168.1.254	192.168.1.0 / 255.255.255.0
192.168.0.1 to 192.168.255.254	192.168.0.0 / 255.255.0.0
192.168.1.1 to 192.168.1.126	192.168.1.0 / 255.255.255.128
192.168.1.129 to 192.168.1.254	192.168.1.128 / 255.255.255.128

System Management—DoS Defense

Users can select from several options to enable DoS Defense in order to fend off cybersecurity attacks. A denial-of-service (DoS) attack is an attempt to make a machine or a network resource unavailable. Users can select from the following options to counter DoS attacks.

DoS Defense

Configuration

Null Scan

NMAP-Xmas Scan

SYN/FIN Scan

FIN Scan

NMAP-ID Scan

SYN-Flood

Enable

Limit (pkt/s)

ICMP-Death

Enable

Limit (pkt/s)

System Management—System Log Settings

The system log settings enable the MGate firmware to record important events, which can be record in two ways: Syslog and Local Log (stored in the MGate).

System Log Settings

Event Group	Syslog	Local Log	Summary
System	<input type="checkbox"/>	<input type="checkbox"/>	System cold start, System warm start
Network	<input type="checkbox"/>	<input type="checkbox"/>	DHCP/BOOTP get IP/renew, NTP connect fail, IP conflict, Network link down
Configuration	<input type="checkbox"/>	<input type="checkbox"/>	Login, IP changed, Password changed, Firmware upgrade, SSL certificate import, Config import, Config export, Configuration change, Clear event log
IEC 61850 server	<input type="checkbox"/>	<input type="checkbox"/>	IEC 61850 server communication logs
Modbus TCP	<input type="checkbox"/>	<input type="checkbox"/>	Modbus TCP communication logs
IEC 60870-5-101	<input type="checkbox"/>	<input type="checkbox"/>	IEC 60870-5-101 communication logs
IEC 60870-5-104	<input type="checkbox"/>	<input type="checkbox"/>	IEC 60870-5-104 communication logs
DNP3 master	<input type="checkbox"/>	<input type="checkbox"/>	DNP3 master communication logs

Local Log Settings

Enable log capacity warning at (%)

Warning by: SNMP Trap E-mail

Event log oversize action :

Syslog Settings

Syslog server IP

Syslog server port

The information that can be recorded includes the following events:

Event Group	Description
System	System Cold Start, System Warm Start
Network	DHCP/BOOTP Get IP/Renew, NTP Connect Fail, IP Conflict, Network Link Down
Configuration	Login Fail, IP Changed, Password Changed, Firmware Upgrade, SSL Certificate Import, Configuration Import/Export, Configuration Change, Clear Event Log
IEC 61850 server	IEC 61850 communication logs
Modbus TCP	Modbus TCP communication logs
IEC 60870-5-101	IEC 60870-5-101 communication logs
IEC 60870-5-104	IEC 60870-5-104 communication logs
DNP3 master	DNP3 communication logs

Local Log Settings	Description
Enable log capacity warning (%)	When the log amount exceeds the warning percentage, it will trigger an event to SNMP Trap or Email.
Warning by	SNMP Trap Email
Event log oversize action	Overwrites the oldest event log Stops recording event log

Syslog Settings	Description
Syslog server IP	IP address of a server which will record the log data
Syslog server port	514

System Management—Auto Warning Settings

❖ Auto Warning Settings

System Event			
Cold start	Mail <input type="checkbox"/>	Trap <input type="checkbox"/>	
Warm start	Mail <input type="checkbox"/>	Trap <input type="checkbox"/>	
Power input 1 failure	Mail <input type="checkbox"/>	Trap <input type="checkbox"/>	Relay <input type="checkbox"/>
Power input 2 failure	Mail <input type="checkbox"/>	Trap <input type="checkbox"/>	Relay <input type="checkbox"/>
Ethernet 1 link down	Mail <input type="checkbox"/>	Trap <input type="checkbox"/>	Relay <input type="checkbox"/>
Ethernet 2 link down	Mail <input type="checkbox"/>	Trap <input type="checkbox"/>	Relay <input type="checkbox"/>
Config Event			
Login failed	Mail <input type="checkbox"/>	Trap <input type="checkbox"/>	
IP changed	Mail <input type="checkbox"/>		
Password changed	Mail <input type="checkbox"/>		

Submit

Auto Warning is triggered by different events. When a checked trigger condition occurs, the MGate can send email alerts, SNMP Trap messages, or open/close the circuit of the relay output and trigger the Fault LED to blink. To enable an email alert, configure the email address on the **Email Alert** page. Likewise, to enable SNMP trap alerts, configure SNMP trap server on the **SNMP Trap** page.

System Management—Email Alert

❖ E-Mail Alert

Mail Settings	
Mail server (SMTP)	<input type="text"/>
<input type="checkbox"/> My server requires authentication	
Username	<input type="text"/>
Password	<input type="password"/>
From e-mail address	<input type="text"/>
To e-mail address 1	<input type="text"/>
To e-mail address 2	<input type="text"/>
To e-mail address 3	<input type="text"/>
To e-mail address 4	<input type="text"/>

Submit

Parameters	Description
Mail server (SMTP)	The mail server’s domain name or IP address.
Username	This field is for your mail server’s username, if required.
Password	This field is for your mail server’s password, if required.
From email address	This is the email address from which automatic email warnings will be sent.
To email address 1 to 4	Email addresses to which automatic email warnings will be sent.

System Management—SNMP Trap

❖ SNMP Trap

SNMP Trap	
SNMP trap server IP or domain name	<input type="text"/>
Trap version	<input checked="" type="radio"/> v1 <input type="radio"/> v2c
Trap community	<input type="text" value="public"/>

Submit

Parameters	Description
SNMP trap server IP	Use this field to show the IP address that is used for receiving SNMP traps.
Trap version	Use this field to select the SNMP trap version.
Trap community	Use this field to designate the SNMP trap community.

System Management—SNMP Agent

❖ SNMP Agent Settings

Configuration

SNMP	Enable ▾
Contact name	<input type="text"/>
Read community string	public
Write community string	private
SNMP agent version	V1, V2c ▾
Read-only username	rouser
Read-only authentication mode	Disable ▾
Read-only password	<input type="text"/>
Read-only privacy mode	Disable ▾
Read-only privacy	<input type="text"/>
Read/write username	rwuser
Read/write authentication mode	Disable ▾
Read/write password	<input type="text"/>
Read/write privacy mode	Disable ▾
Read/write privacy	<input type="text"/>

Submit

Parameters	Description
SNMP	To enable the SNMP Agent function, select the Enable option, and enter a community name (e.g., public).
Contact name	The optional SNMP contact information usually includes an emergency contact name and telephone number.
Read community string	This is a text password mechanism that is used to weakly authenticate queries to agents of managed network devices.
Write community string	This is a text password mechanism that is used to weakly authenticate changes to agents of managed network devices.
SNMP agent version	The MGate 5119 supports SNMP V1, V2c, and V3.

Read-only and Read/write access control

The following fields allow you to define usernames, passwords, and authentication parameters for two levels of access: read-only and read/write. The name of the field will show which level of access it refers to. For example, **Read-only** authentication mode allows you to configure the authentication mode for read-only access, whereas **Read/write** authentication mode allows you to configure the authentication mode for read/write access. For each level of access, you may configure the following:

Parameters	Description
Username	Use this optional field to identify the username for the specified level of access.
Authentication mode	Use this field to select MD5 or SHA as the method of password encryption for the specified level of access, or to disable authentication.
Privacy mode	Use this field to enable or disable DES_CBC data encryption for the specified level of access.
Password	Use this field to set the password for the specified level of access.
Privacy	Use this field to define the encryption key for the specified level of access.

System Management—LLDP Settings

The Link Layer Discovery Protocol (LLDP) standardizes the method that devices on a network periodically use to send information about their configuration and status. This self-identification method keeps all LLDP devices on a network informed of each other's status and configuration. You can use SNMP protocol to send the LLDP information on the network devices to Moxa's MXview to create auto network topology and for network visualization.

The MGate web interface lets you enable or disable LLDP and set the LLDP transmit interval. In addition, you can go to **System Monitoring—System Status—LLDP Table** to view the MGate's neighbor-list, which is created based on the information reported by neighboring devices on the network.

⚙️ LLDP Settings

Configuration

LLDP Enable ▾

Message transmit interval (5 - 16383 secs)

Parameters	Values	Description
Message transmit interval	5 to 16383 secs (Default:30 secs)	MGate will send information on the configuration and status of devices in a network at regular intervals based on the value configured here.

System Management—Certificate

⚙️ Certificate

SSL Certificate

Issued to 192.168.127.254

Issued by 192.168.127.254

Valid from 2021/11/25 to 2031/11/23

Select SSL certificate file No file chosen

Delete SSL certificate file

Use this function to load the Ethernet SSL certificate. Select or browse for the certificate file in the Select SSL certificate/key file field. This function is only available on the web console

System Management—Misc. Settings

It includes console settings, password and relay output.

System Management—Misc. Settings—Console Settings

Console Settings

Configurations	
HTTP console	Enable ▼
HTTPS console	Enable ▼
Telnet console	Disable ▼
SSH console	Enable ▼
Serial console	Enable ▼
Reset button	Always enable ▼
MOXA command	Enable ▼
Accept arbitrary host header	Disable ▼
Session Settings	
Maximum login user for HTTP+HTTPS	<input type="text" value="5"/> (1 ~ 10)
Auto logout setting	<input type="text" value="5"/> (1 ~ 1440 min)

Submit

Configuration	Value	Description
HTTP/HTTPS	Enable/Disable	This setting is to enable/disable the web console. For security issues, users can only enable the HTTPS or just disable all settings.
Telnet/SSH	Enable/Disable	The MGate Telnet/SSH function can be enabled or disabled.
Serial console	Enable/Disable	The MGate serial console function can be enabled or disabled.
Reset button protect	Disable after 60 sec, Always enable	MGate provides the reset button to clear password or load factory default settings. But for security issues, users can disable this function. In disabled mode, MGate will still enable this function within 60 seconds after boot-up, just in case users really need to reset this function.
MOXA command	Enable/Disable	The DSU can search for the MGate. If you have any security concerns, you can choose Disable to deny the DSU the right to access.
Accept arbitrary host header	Enable/Disable	If a web service accepts a connection using arbitrary HTTP Host headers, attackers may use DNS rebinding to bypass any IP or firewall-based access restrictions that may be in place, by proxying through their target's browser. The website may be vulnerable to HTTP Host header attacks by enabling this function. Therefore, the default setting is disabled.

Session Settings	Value	Description
Maximum Login Users for HTTP+HTTPS	1 to 10	The number of users that can access the MGate at the same time.
Auto Logout Setting	0 to 1440 min.	Sets the auto logout time period.

System Management—Misc. Settings—Notification Message

❖ Notification Message

Notification Message

Login message

0 character/Maximum 240 character

Login authentication failure message

111 character/Maximum 240 character

Users can input a message for Login or for Login authentication failure message.

System Management—Misc. Settings—Account Management

❖ Account Management

Add Account Settings

➕ Add
✎ Edit
🗑 Delete

Account Name	Group
admin	admin
user	user

Submit

Parameters	Value	Description
Account	admin, user	Users can change the password for different accounts. MGate provides two different level accounts: admin and user . Admin account can access and change all the settings through the web console. User account can only view the settings and can't change anything.

System Management—Misc. Settings—Login Password Policy

⚙️ Login Password Policy

Account Password Policy

Minimum length (4 ~ 16)

Enable password complexity strength check

- At least one digit(0-9)
- Mixed upper and lower case letters(A-Z, a-z)
- At least one special character: ~!@#%&*~_!;:.,<>[]{}()

Password lifetime (90 ~ 180 days)

Account Login Failure Lockout

Enable

Retry failure threshold (1 ~ 10 time)

Lockout time (1 ~ 60 min)

Account Password Policy	Value	Description
Minimum length	4 to 16	The minimum password length
Enable password complexity strength check		Select how the MGate checks the password's strength
Password lifetime	90 to 180 days	Set the password's lifetime period.

Account Login Failure Lockout	Value	Description
Retry failure threshold	1 to 10 time	Shows the number of login failures before the MGate locks out.
Lockout time	1 to 60 min	When the number of login failures exceeds the threshold, the MGate will lock out for a period.

System Management—Maintenance

System Management—Maintenance—Ping

This network testing function is available only in the web console. The MGate gateway will send an ICMP packet through the network to a specified host, and the result can be viewed in the web console immediately.

⚙️ Ping Test

Ping Destination

Destination

System Management—Maintenance—Firmware Upgrade

Firmware updates for the MGate 5119 are at www.moxa.com. After you have downloaded the new firmware onto your PC, you can use the web console to write it onto your MGate 5119. Select the desired unit from the list in the web console and click **Submit** to begin the process.

⚙️ Firmware Upgrade

!!! Warning !!!

Upgrading firmware may cause MGate devices to reset to factory default. We suggest you back up the configuration of all MGate devices.

Select firmware file

Choose File No file chosen

Submit



ATTENTION

DO NOT turn off the MGate power before the firmware upgrade process is completed. The MGate will erase the old firmware to make room for the new firmware to flash memory. If you power off the MGate and end the progress, the flash memory will contain corrupted firmware and the MGate will fail to boot. If this happens, contact Moxa RMA services.

System Management—Maintenance—Configuration Import/Export

There are three main reasons for using the Import and Export functions:

- **Applying the same configuration to multiple units.** The Import/Export configuration function is a convenient way to apply the same settings to units in different sites. You can export the configuration as a file and then import the configuration file onto other units.
- **Backing up configurations for system recovery.** The export function allows you to export configuration files that can be imported onto other gateways to restore malfunctioning systems within minutes.
- **Troubleshooting.** Exported configuration files can help administrators to identify system problems that provide useful information for Moxa’s Technical Service Team when maintenance visits are requested

⚙️ Configuration Import/Export

Configuration Import

Select configuration file

Choose File No file chosen

Keep IP settings

Import

Configuration Export

Export

System Management—Maintenance—Load Factory Default

To clear all the settings on the unit, use the Load Factory Default to reset the unit to its initial factory default values.

⚙️ Load Factory Default

Click on **Submit** to reset all settings, including the console password, to the factory default values. To leave the IP address, netmask, and gateway settings unchanged, make sure that **Keep IP settings** is enabled.

Reset to Factory Default

Keep IP settings

Submit



ATTENTION

Load Default will completely reset the configuration of the unit, and all the parameters you have saved will be discarded. Do not use this function unless you are sure you want to completely reset your unit.

System Monitoring (Troubleshooting)

The MGate 5119 provides easy-to-use and useful troubleshooting tools. If a communication issue occurs, we suggest that you first check the **Protocol Status** → **Diagnostic** page for the status of the protocol. To analyze the traffic, view the network logs available at **Protocol Status** → **Traffic**.

System Monitoring—System Status

System Monitoring—System Status—Network Connections

Go to **Network Connections** under **System Status** to view network connection information.

⚙️ Network Connections

Auto refresh

Protocol	Recv-Q	Send-Q	Local Address	Foreign Address	State
TCP	0	0	*:2404	*:0	LISTEN
TCP	0	0	*:4900	*:0	LISTEN
TCP	0	0	*:80	*:0	LISTEN
TCP	0	0	*:22	*:0	LISTEN
TCP	0	0	*:23	*:0	LISTEN
TCP	0	0	*:443	*:0	LISTEN
TCP	0	0	192.168.127.254:80	192.168.127.1:58950	ESTABLISHED
UDP	0	0	*:161	*:0	
UDP	0	0	*:4800	*:0	

System Monitoring—System Status—System Log

Go to **Network Connections** under **System Log** to view the history of the logs.

System Log

System Log

Export
Clear log
Refresh

System Monitoring—System Status—Relay State

The MGate gateway includes a built-in relay circuit that is triggered in the event of a power failure or if the Ethernet link is down. You can view the relay status on this page.

Relay State

Auto refresh

Power input 1 failure	N/A	Acknowledge Event
Power input 2 failure	N/A	Acknowledge Event
Ethernet 1 link down	N/A	Acknowledge Event
Ethernet 2 link down	N/A	Acknowledge Event

System Monitoring—System Status—LLDP Table

You can see LLDP related information, including Port, Neighbor ID, Neighbor Port, Neighbor Port Description, and Neighbor System.

LLDP Table

Port	Neighbor ID	Neighbor Port	Neighbor Port Description	Neighbor System
sw0	ks-hsu01	port-001		KS-HSU01

System Monitoring—Protocol Status

System Monitoring—Protocol Status—Tag View

This page displays the tag live value generated by field devices and updates the values periodically. It is an easy and useful tool if you want to check whether the MGate receives correct data from field devices. If the protocol communicates data with a timestamp, such as IEC 60870-5-101/104 or DNP3, the source timestamp comes from the device.

If the protocol communicates data without a timestamp, such as Modbus, it will generate the source timestamp when the MGate receives the data from the device.

The gateway timestamp shows the time to update the data to the tag.

Tag View

Auto refresh

Tag List

Provider Name	Source Name	Tag Name	Access	Type	Size(Bytes)	Value	Quality	Source Timestamp	Gateway Timestamp
modbus_tcp_client	192.168.127.1:502-sid1	DI	r	boolean	1	Off(0)	unknown	N/A	2021-11-18 06:50:37
modbus_tcp_client	192.168.127.1:502-sid1	Voltage	r	int16	2	0	unknown	N/A	2021-11-18 06:50:37
modbus_tcp_client	192.168.127.1:502-sid1	status	r	uint16	2	Invalid(0)	valid	2021-11-18 06:50:37	2021-11-18 06:50:37

System Monitoring—Protocol Status—Diagnostics

The MGate provides status information for Modbus RTU/ASCII/TCP, IEC 60870-5-101, and IEC 60870-5-104 troubleshooting. Verify data or packet counters to make sure the communications are running smoothly.

Modbus RTU/ASCII Diagnostics (Master)

Modbus RTU/ASCII Diagnostics

Auto refresh

Category	Item	Value
Modbus	Mode	RTU Master
	Sent request	1265
	Received valid responses	0
	Received invalid responses	0
	Received CRC/LRC errors	0
	Received exceptions	0
	Timeout	1264
Serial Port	Port number	1
	Break	0
	Frame error	0
	Parity error	0
	Overrun error	0

Modbus TCP Diagnostics (Client/Master)

⚙️ Modbus TCP Diagnostics

Auto refresh

Category	Item	Value
Modbus	Mode	Master
	Number of connections	0
	Sent requests	0
	Received valid responses	0
	Received invalid responses	0
	Received exceptions	0
	Timeout	0
Connections		

IEC 60870-5-104 Diagnostics (Client)

⚙️ IEC 60870-5-104 Client Diagnostics

Auto refresh

Select connected device ▾

Device Details

Status Disconnected
 Latest COT 0x0000, UNDEFINED
 Error Message OK

Point Information

Single Point ▾

IOA	Value	Flags	Time Tag	Time Updated
1	OFF	VALID	1999-11-30 00:00:00	N/A
2	OFF	VALID	1999-11-30 00:00:00	N/A
3	OFF	VALID	1999-11-30 00:00:00	N/A
4	OFF	VALID	1999-11-30 00:00:00	N/A
5	OFF	VALID	1999-11-30 00:00:00	N/A
6	OFF	VALID	1999-11-30 00:00:00	N/A
7	OFF	VALID	1999-11-30 00:00:00	N/A
8	OFF	VALID	1999-11-30 00:00:00	N/A
9	OFF	VALID	1999-11-30 00:00:00	N/A
10	OFF	VALID	1999-11-30 00:00:00	N/A

IEC 60870-5-101 Diagnostics (Master)

⚙️ IEC 60870-5-101 Master Diagnostics

Auto refresh

Select connected device ▾

Device Details

Latest COT 0x0000, UNDEFINED
 Error Message OK

Point Information

Single Point ▾

IOA	Value	Flags	Time Tag	Time Updated
1	OFF	VALID	1999-11-30 00:00:00	N/A
2	OFF	VALID	1999-11-30 00:00:00	N/A
3	OFF	VALID	1999-11-30 00:00:00	N/A
4	OFF	VALID	1999-11-30 00:00:00	N/A
5	OFF	VALID	1999-11-30 00:00:00	N/A
6	OFF	VALID	1999-11-30 00:00:00	N/A
7	OFF	VALID	1999-11-30 00:00:00	N/A
8	OFF	VALID	1999-11-30 00:00:00	N/A
9	OFF	VALID	1999-11-30 00:00:00	N/A
10	OFF	VALID	1999-11-30 00:00:00	N/A

DNP3 Serial Master Diagnose

⚙️ DNP3 Serial Master Diagnose

Auto refresh

Select connected device All ▼

Communication Statistics

Name	DNP3 Address	Msg Tx	Msg Rx	Last Msg Tx Time	Last Msg Rx Time
Outstation2	2	0	0	N/A	N/A
Outstation3	3	0	0	N/A	N/A

⚙️ DNP3 Serial Master Diagnose

Auto refresh

Select connected device Outstation address 2 ▼

Device Details

Status	Connected
Internal Indications	0x0000
Received Binary Input Event Count	0
Received Counter Event Count	0
Received Analog Input Event Count	0

Point Information

Binary Input ▼

Point Index	Value	Flags	Time Updated
0	OFF	N/A	N/A
1	OFF	N/A	N/A
2	OFF	N/A	N/A
3	OFF	N/A	N/A
4	OFF	N/A	N/A
5	OFF	N/A	N/A
6	OFF	N/A	N/A
7	OFF	N/A	N/A
8	OFF	N/A	N/A
9	OFF	N/A	N/A
10	OFF	N/A	N/A

DNP3 TCP/UDP Master Diagnose

⚙️ DNP3 TCP/UDP Master Diagnose

Auto refresh

Select connected device All ▼

Communication Statistics

Name	DNP3 Address	IP Address	Msg Tx	Msg Rx	Last Msg Tx Time	Last Msg Rx Time
Outstation2	2	192.168.127.112:20000	0	0	N/A	N/A
Outstation3	3	192.168.127.113:20000	0	0	N/A	N/A

⚙️ DNP3 TCP/UDP Master Diagnose

Auto refresh

Select connected device

Device Details

Status	Disconnected
Internal Indications	0x0000
Received Binary Input Event Count	0
Received Counter Event Count	0
Received Analog Input Event Count	0

Point Information

Binary Input	Value	Flags	Time Updated
Binary Output Counter	OFF	N/A	N/A
Frozen Counter	OFF	N/A	N/A
Analog Input	OFF	N/A	N/A
Analog Output	OFF	N/A	N/A
2	OFF	N/A	N/A
3	OFF	N/A	N/A
4	OFF	N/A	N/A
5	OFF	N/A	N/A

IEC 61850 Diagnostics

⚙️ IEC61850 Server Diagnostics

Auto refresh

Category	Item	Value
IEC61850 Server		
	Number of connections	1
	Received indications	1140
	Sent response ok	1140
	Sent response error	0
	Read variable ok	3393
	Read variable error	0
	Write variable ok	0
	Write variable error	0
Connections		
Client 1		
	Remote IP	192.168.127.1
	Received indications	1140
	Sent response ok	1140
	Sent response error	0
	Read variable ok	3393
	Read variable error	0
	Write variable ok	0
	Write variable error	0

System Monitoring—Protocol Status—Traffic

In order to troubleshoot efficiently, the MGate provides a traffic monitoring function that can capture communication traffic for all protocols. These logs present the data in an intelligent, easy-to-understand format with clearly designated fields, including source, destination, function code, and data. Save the complete log in a file by clicking **Export TXT File** or **Export PCAP File** for later analysis. For the PCAP file specifically, it is compatible with the popular troubleshooting tool Wireshark that can easily find the root cause. Here is an example of Modbus TCP IEC 61850 traffic.

The size of the traffic logs for each protocol:

Protocols	Log Size
Modbus RTU/ASCII	16 KB
Modbus TCP	16 KB
IEC 60870-5-101	64 KB
IEC 60870-5-104	16 KB
DNP3 Serial	256 KB
DNP3 TCP	256 KB
IEC 61850	16 KB

NOTE If the packet exceeds the upper limit, it will stop recording.

NOTE We suggest you execute only one traffic monitor application at a time. If you execute two or more applications simultaneously, it may affect the system's performance.

Modbus TCP Traffic

Modbus TCP Traffic

Auto scroll

Start Stop Export TXT File Export PCAP File Capturing ...

No.	Time	Send/Receive	Remote IP : port	Slave ID	Function Code	Data
1	0.057	Send	192.168.127.1:502	1	3	FF 0A 00 00 00 06 01 03 00 01 00 01
2	0.079	Receive	192.168.127.1:502	1	3	FF 0A 00 00 00 05 01 03 02 00 00
3	1.056	Send	192.168.127.1:502	1	3	FF 0B 00 00 00 06 01 03 00 01 00 01
4	1.068	Receive	192.168.127.1:502	1	3	FF 0B 00 00 00 05 01 03 02 00 00
5	2.055	Send	192.168.127.1:502	1	3	FF 0C 00 00 00 06 01 03 00 01 00 01
6	2.067	Receive	192.168.127.1:502	1	3	FF 0C 00 00 00 05 01 03 02 00 00
7	3.055	Send	192.168.127.1:502	1	3	FF 0D 00 00 00 06 01 03 00 01 00 01
8	3.069	Receive	192.168.127.1:502	1	3	FF 0D 00 00 00 05 01 03 02 00 00
9	4.055	Send	192.168.127.1:502	1	3	FF 0E 00 00 00 06 01 03 00 01 00 01
10	4.067	Receive	192.168.127.1:502	1	3	FF 0E 00 00 00 05 01 03 02 00 00
11	5.056	Send	192.168.127.1:502	1	3	FF 0F 00 00 00 06 01 03 00 01 00 01
12	5.068	Receive	192.168.127.1:502	1	3	FF 0F 00 00 00 05 01 03 02 00 00

IEC 61850 Traffic

IEC 61850 Server Traffic

Auto scroll

Start Stop Export TXT File Export PCAP File Capturing ...

No.	Time	Send/Receive	Remote IP	Data
1	0.695	Receive	192.168.127.1	03 00 00 A1 02 F0 80 01 00 01 00 61 81 93 30 81 90 02 01 03 A0 81 8A A0 81 87 02 02 04 D0 A4 81 80 80 01 00 A1 7B A0 79 30 24 A0 22 A1 20 1A 0C 69 65 64 31 6C 44 65 76 69 63 65 31 1A 10 47 47 49 4F 31 24 4D 58 24 41 6E 49 6E 31 24 71 30 28 A0 26 A1 24 1A 0C 69 65 64 31 6C 44 65 76 69 63 65 31 1A 14 47 47 49 4F 31 24 4D 58 24 41 6E 49 6E 31 24 6D 61 67 24 66 30 27 A0 25 A1 23 1A 0C 69 65 64 31 6C 44 65 76 69 63 65 31 1A 13 47 47 49 4F 31 24 53 54 24 49 6E 64 31 24 73 74 56 61 6C
2	0.698	Send	192.168.127.1	03 00 00 2D 02 F0 80 01 00 01 00 61 20 30 1E 02 01 03 A0 19 A1 17 02 02 04 D0 A4 11 A1 0F 84 03 03 00 00 87 05 08 44 9B A0 00 83 01 00
3	1.715	Receive	192.168.127.1	03 00 00 A1 02 F0 80 01 00 01 00 61 81 93 30 81 90 02 01 03 A0 81 8A A0 81 87 02 02 04 D1 A4 81 80 80 01 00 A1 7B A0 79 30 24 A0 22 A1 20 1A 0C 69 65 64 31 6C 44 65 76 69 63 65 31 1A 10 47 47 49 4F 31 24 4D 58 24 41 6E 49 6E 31 24 71 30 28 A0 26 A1 24 1A 0C 69 65 64 31 6C 44 65 76 69 63 65 31 1A 14 47 47 49 4F 31 24 4D 58 24 41 6E 49 6E 31 24 6D 61 67 24 66 30 27 A0 25 A1 23 1A 0C 69 65 64 31 6C 44 65 76 69 63 65 31 1A 13 47 47 49 4F 31 24 53 54 24 49 6E 64 31 24 73 74 56 61 6C
4	1.717	Send	192.168.127.1	03 00 00 2D 02 F0 80 01 00 01 00 61 20 30 1E 02 01 03 A0 19 A1 17 02 02 04 D1 A4 11 A1 0F 84 03 03 00 00 87 05 08 44 9B C0 00 83 01 01
5	2.744	Receive	192.168.127.1	03 00 00 A1 02 F0 80 01 00 01 00 61 81 93 30 81 90 02 01 03 A0 81 8A A0 81 87 02 02 04 D2 A4 81 80 80 01 00 A1 7B A0 79 30 24 A0 22 A1 20 1A 0C 69 65 64 31 6C 44 65 76 69 63 65 31 1A 10 47 47 49 4F 31 24 4D 58 24 41 6E 49 6E 31 24 71 30 28 A0 26 A1 24 1A 0C 69 65 64 31 6C 44 65 76 69 63 65 31 1A 14 47 47 49 4F 31 24 4D 58 24 41 6E 49 6E 31 24 6D 61 67 24 66 30 27 A0 25 A1 23 1A 0C 69 65 64 31 6C 44 65 76 69 63 65 31 1A 13 47 47 49 4F 31 24 53 54 24 49 6E 64 31 24 73 74 56 61 6C
6	2.747	Send	192.168.127.1	03 00 00 2D 02 F0 80 01 00 01 00 61 20 30 1E 02 01 03 A0 19 A1 17 02 02 04 D2 A4 11 A1 0F 84 03 03

Status Monitoring

For agent mode design, if a slave device fails, or a cable comes loose, the gateway cannot receive up-to-date data from the slave device. The out-of-date data will be stored in the gateway’s memory and will be retrieved by the client/master system, which will not be aware that the slave device is not providing up-to-date data. The MGate 5119 supports the Status Monitoring function, which provides a warning mechanism to report the list of slave devices that are still active, for example, the MGate as Modbus TCP client and IEC 61850 server.

Protocol Conversion

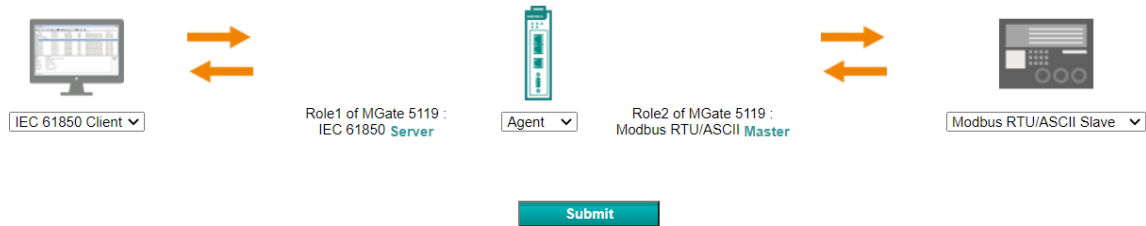

If the MGate detects a Modbus communication error, the corresponding quality(q) of IEC 61580 objects will show **invalid**. However, if the MGate Modbus is working fine, the corresponding quality(q) of IEC 61580 objects will show **good**.

ied1 • Data Model • IDevice1 • GGIO1		
LN GGIO1 Generic process I/O		
Name	Value	
DO AnIn1	0	!
DO Beh	on	
DO Mod	on	
DO EEHealth	0	
DO Ind1	false	!
DA stVal	[ST] false	
DA q	[ST] invalid	!
DA t	[ST] 10/7/2021 2:01:48.176 PM	

The conditions for when **quality(q)** of the IEC 61850 server shows **Invalid**.

Protocols	Conditions
Modbus RTU	Command timeout, received exception code
Modbus TCP	Command timeout, received exception code, disconnected communication
IEC 60870-5-101	The source of flag shows invalid, overflow
IEC 60870-5-104	The source of flag shows invalid, overflow
DNP3 Serial	The source of flag shows OFFLINE, COMM_LOST, OVER_RANGE, REFERENCE_ERR
DNP3 TCP	The source of flag shows OFFLINE, COMM_LOST, OVER_RANGE, REFERENCE_ERR

The MGate supports device status. When we create southbound device settings, each device has its own status that is used to monitor device communication status. You can map status to the IEC 61850, then you can monitor the southbound device status in IEC 61850 client. Once the MGate detects response timeout or a disconnected connection, the device status will turn to invalid (0). Instead, for other conditions, the device status will be valid (1).

Configuration (Text Mode Console)

The MGate 5119 supports a text-mode console with serial interface, Telnet, and SSH protocol. The user interface is the same in all text mode consoles. Note that the text mode console does not support all configuration items. You must configure some parameters through the web console.

You must use a DB9-to-RJ45 cable to connect the serial console port on the MGate gateway's front panel to the serial port on the host. The serial console parameters are 115.2 kbps; parity: none; 8 data bits; and one stop bit (115200, 8/N/1).

For Telnet and SSH, use HyperTerminal or PuTTY to connect to the MGate. Note that the Telnet protocol will transfer the account and password information over the Internet using plain text, so Telnet is essentially obsolete and should be replaced by the SSH protocol.

To connect to the MGate Telnet/SSH console, load the Telnet/SSH program and connect to the MGate IP address.

On the first page, input the account and password. The account supports two types of users: **admin** and **user**. An "admin" account can change all of the settings, but a "user" account can only review the settings. A "user" account cannot change the configuration. The default password for **admin** is **moxa**.

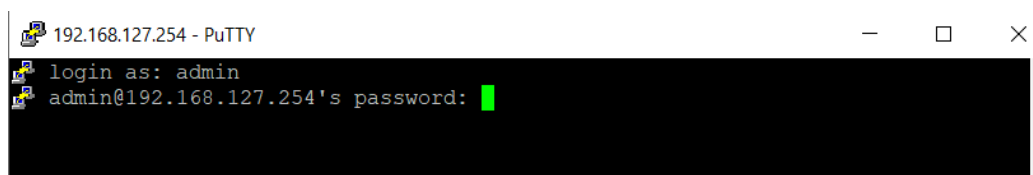

```
192.168.127.254 - PuTTY
login as: admin
admin@192.168.127.254's password: █
```

The text mode console will display the menu-driven interface. Users can use an arrow key to move the menu bar. To select the option, press the **Enter** key to go to the next level menu. To go to previous level menu, press the **Esc** key to quit. If necessary, the MGate will need to restart to activate the setting.

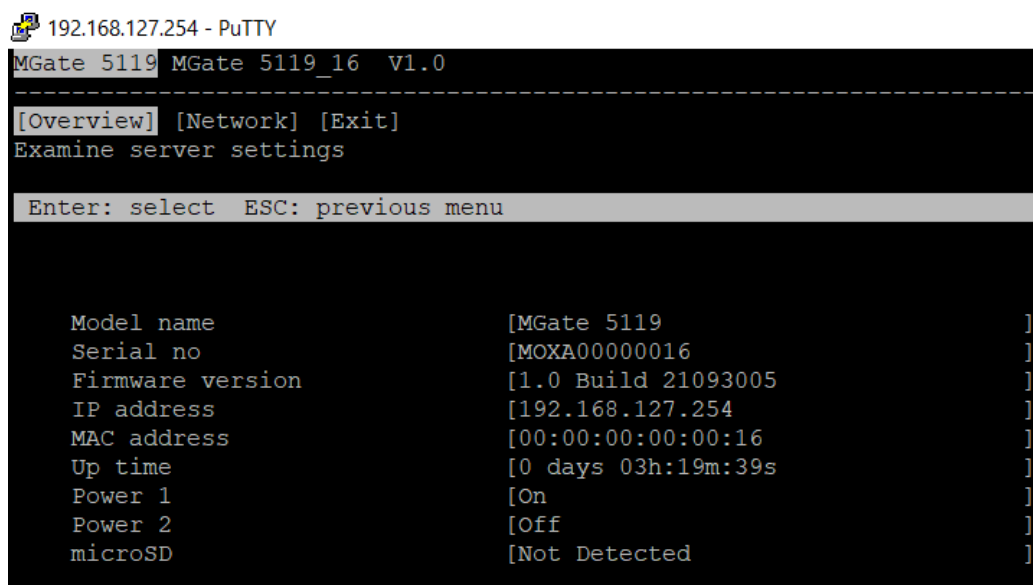

```
192.168.127.254 - PuTTY
MGate 5119 MGate 5119_16 V1.0
-----
[Overview] [Network] [Exit]
Examine server settings

Enter: select  ESC: previous menu

Model name           [MGate 5119           ]
Serial no            [MOXA00000016        ]
Firmware version     [1.0 Build 21093005   ]
IP address           [192.168.127.254     ]
MAC address          [00:00:00:00:00:16    ]
Up time              [0 days 03h:19m:39s  ]
Power 1              [On                   ]
Power 2              [Off                  ]
microSD              [Not Detected         ]
```

Network Management Tool (MXstudio)

Moxa's MXstudio industrial network management suite includes tools such as MXconfig, MXview and N-Snap. MXconfig is for industrial network configuration; MXview is for industrial management software; and N-Snap is for industrial network snapshot. The MXstudio suite in the MGate 5119 includes MXconfig and MXview, which are used for mass configuration of network devices and monitoring network topology, respectively. The following functions are supported:

Tool	Function Support
MXconfig	<ol style="list-style-type: none">1. System name and login password modification2. Network settings3. Configuration import/export4. Firmware upgrade
MXview	<ol style="list-style-type: none">1. Configuration import/export2. LLDP for topology analysis3. Security View**

**Security View can check the security level of devices under the IEC62443-4-2 standard.

A

SNMP Agents with MIB II and RS-232-Like Groups

The MGate 5119 has built-in Simple Network Management Protocol (SNMP) agent software that supports SNMP Trap, RFC1317 and RS-232-like groups, and RFC 1213 MIB-II.

The following topics are covered in this Appendix:

- **RFC1213 MIB-II Supported SNMP Variables**
- **RFC1317 RS-232-Like Groups**

RFC1213 MIB-II Supported SNMP Variables

System MIB	Interfaces MIB	IP MIB	ICMP MIB
sysDescr	ifNumber	ipForwarding	icmpInMsgs
sysObjectID	ifIndex	ipDefaultTTL	icmpInErrors
sysUpTime	ifDescr	ipInReceives	icmpInDestUnreachs
sysContact	ifType	ipInHdrErrors	icmpInTimeExcds
sysName	ifMtu	ipInAddrErrors	icmpInParmProbs
sysLocation	ifSpeed	ipForwDatagrams	icmpInSrcQuenchs
sysServices	ifPhysAddress	ipInUnknownProtos	icmpInRedirects
	ifAdminStatus	ipInDiscards	icmpInEchos
	ifOperStatus	ipInDelivers	icmpInEchoReps
	ifLastChange	ipOutRequests	icmpInTimestamps
	ifInOctets	ipOutDiscards	icmpTimestampReps
	ifInUcastPkts	ipOutNoRoutes	icmpInAddrMasks
	ifInNUcastPkts	ipReasmTimeout	icmpInAddrMaskReps
	ifInDiscards	ipReasmReqds	icmpOutMsgs
	ifInErrors	ipReasmOKs	icmpOutErrors
	ifInUnknownProtos	ipReasmFails	icmpOutDestUnreachs
	ifOutOctets	ipFragOKs	icmpOutTimeExcds
	ifOutUcastPkts	ipFragFails	icmpOutParmProbs
	ifOutNUcastPkts	ipFragCreates	icmpOutSrcQuenchs
	ifOutDiscards	ipAdEntAddr	icmpOutRedirects
	ifOutErrors	ipAdEntIfIndex	icmpOutEchos
	ifOutQLen	ipAdEntNetMask	icmpOutEchoReps
	ifSpecific	ipAdEntBcastAddr	icmpOutTimestamps
		ipAdEntReasmMaxSize	icmpOutTimestampReps
		ipRouteDest	icmpOutAddrMasks
		ipRouteIfIndex	icmpOutAddrMaskReps
		ipRouteMetric1	
		ipRouteMetric2	
		ipRouteMetric3	
		ipRouteMetric4	
		ipRouteNextHop	
		ipRouteType	
		ipRouteProto	
		ipRouteAge	
		ipRouteMask	
		ipRouteMetric5	
		ipRouteInfo	
		ipNetToMediaIfIndex	
		ipNetToMediaPhysAddress	
		ipNetToMediaNetAddress	
		ipNetToMediaType	
		ipRoutingDiscards	

Address Translation MIB	TCP MIB	UDP MIB	SNMP MIB
atIfIndex	tcpRtoAlgorithm	udpInDatagrams	snmpInPkts
atPhysAddress	tcpRtoMin	udpNoPorts	snmpOutPkts
atNetAddress	tcpRtoMax	udpInErrors	snmpInBadVersions
	tcpMaxConn	udpOutDatagrams	snmpInBadCommunityNames
	tcpActiveOpens	udpLocalAddress	snmpInBadCommunityUses
	tcpPassiveOpens	udpLocalPort	snmpInASNParseErrs
	tcpAttemptFails		snmpInTooBigs
	tcpEstabResets		snmpInNoSuchNames
	tcpCurrEstab		snmpInBadValues
	tcpInSegs		snmpInReadOnlys
	tcpOutSegs		snmpInGenErrs
	tcpRetransSegs		snmpInTotalReqVars
	tcpConnState		snmpInTotalSetVars
	tcpConnLocalAddress		snmpInGetRequests
	tcpConnLocalPort		snmpInGetNexts
	tcpConnRemAddress		snmpInSetRequests
	tcpConnRemPort		snmpInGetResponses
	tcpInErrs		snmpInTraps
	tcpOutRsts		snmpOutTooBigs
			snmpOutNoSuchNames
			snmpOutBadValues
			snmpOutGenErrs
			snmpOutGetRequests
			snmpOutGetNexts
			snmpOutSetRequests
			snmpOutGetResponses
			snmpOutTraps
			snmpEnableAuthenTraps
			snmpSilentDrops
			snmpProxyDrops

RFC1317 RS-232-Like Groups

RS-232 MIB	Async Port MIB
rs232Number	rs232AsyncPortIndex
rs232PortIndex	rs232AsyncPortBits
rs232PortType	rs232AsyncPortStopBits
rs232PortInSigNumber	rs232AsyncPortParity
rs232PortOutSigNumber	
rs232PortInSpeed	
rs232PortOutSpeed	

Input Signal MIB	Output Signal MIB
rs232InSigPortIndex	rs232OutSigPortIndex
rs232InSigName	rs232OutSigName
rs232InSigState	rs232OutSigState