



RUTX09

User manual v1.1



Wiki knowledge base
<https://wiki.teltonika.lt/>



LEGAL NOTICE

Copyright © 2019 TELTONIKA Ltd. all rights reserved. Reproduction, transfer, distribution or storage of part or all of the contents in this document in any form without the prior written permission of TELTONIKA Ltd is prohibited. The manufacturer reserves the right to modify the product and manual for the purpose of technical improvement without prior notice.

Other product and company names mentioned herein may be trademarks or trade names of their respective owners.

ATTENTION



Before using the device, we strongly recommend reading this user manual first.



Do not disassemble the device. Do not touch the device if the housing is broken.



All wireless devices for data transferring may be susceptible to interference, which could affect performance.



The device is not water-resistant. Keep it dry.



Device is powered by a low voltage 12 VDC power adapter.

SAFETY

To avoid voltage caused traumas please follow these safety requirements:

- The device is intended to be powered from Limited Power Source (LPS) with a power of at least 18 W.
 - The overcurrent protective device rated current should not exceed 3A.
 - The highest transient overvoltage in the output (secondary circuit) of used PSU shall not exceed 55 V peak.
 - The device can be used with a Personal Computer (first safety class) or Notebook (second safety class). Associated equipment: PSU (power supply unit) (LPS) and personal computer (PC) shall comply with the requirements of standard EN 60950-1/EN 62368-1.
 - To avoid mechanical damage to the device it is recommended to transport it packed in a damage-proof pack.
- When using the device it should be placed so that its indicating LEDs would be visible as they inform in which working mode the device is in and if it has any working problems.
- Protection against over current, short circuiting and earth faults should be provided as a part of the building installation.

FRONT VIEW

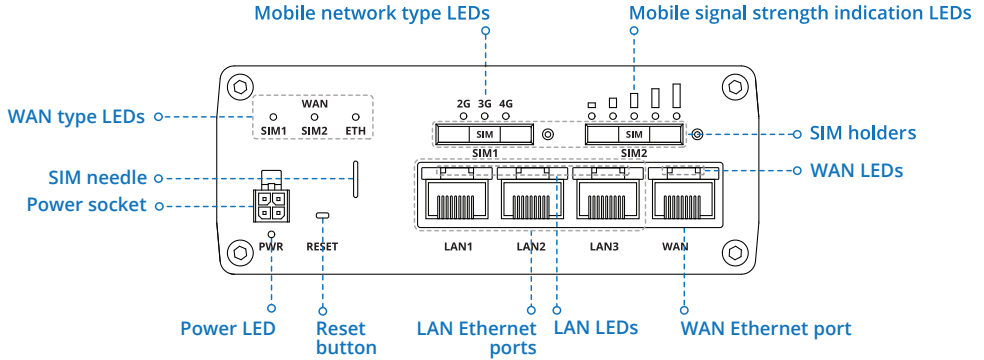

BACK VIEW

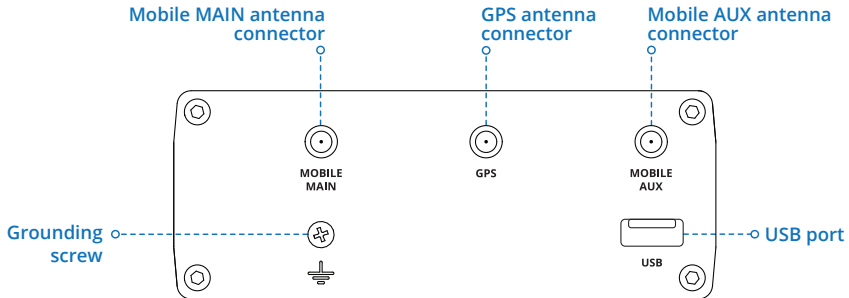

POWER SOCKET PINOUT

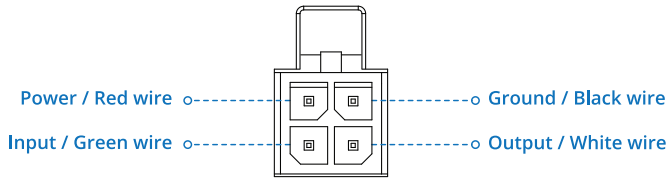

HARDWARE INSTALLATION

1. Pull out the ❶ SIM needle from the front panel of the router.
2. Push the ❷ SIM holder button with the ❶ SIM needle.
3. Pull out the ❸ SIM holder.
4. Insert your ❹ SIM card into the ❸ SIM holder.
5. Slide the ❸ SIM holder back into the router.
6. Attach LTE antennas (max torque 0.4 Nm / 3.5 in-lbs)
7. Connect the power adapter to the socket on the front of the device. Then plug the other end of the power adapter into a power outlet.
8. Connect to the device using an Ethernet cable (connected to LAN port).

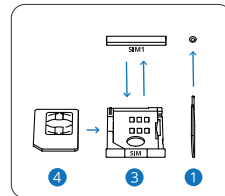
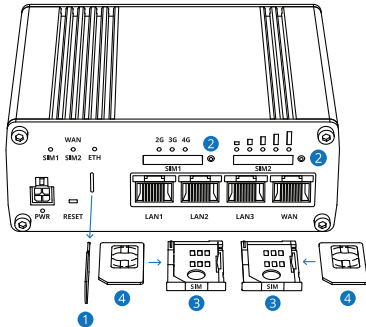

Sim insertion/removal

LED INDICATIONS

- 2G,3G and 4G LEDs constantly blinking sequential: no SIM or bad PIN or searching operator.
- 2G/3G/4G LEDs blinking every 1 sec.: connected to 2G/3G/4G, but no data session established.
- 2G/3G/4G LEDs turned on: connected to 2G/3G/4G with data session.
- SIM1/SIM2/ETH LEDs turned on: SIM1/SIM2/ETH interface turned on.

SIGNAL STRENGTH LEDS

No. of lit up LEDs	Signal strength value
0	≤ -111 dBm
1	-110 dBm to -97 dBm
2	-96 dBm to -82 dBm
3	-81 dBm to -67 dBm
4	-66 dBm to -52 dBm
5	≥ -51 dBm

LOGIN TO DEVICE

1. To enter the router's Web interface (WebUI), type <http://192.168.1.1> into the URL field of your Internet browser.
2. Use login information shown in image A when prompted for authentication.
3. After you log in, you will be prompted to change your password for security reasons. The new password must contain at least 8 characters, including at least one uppercase letter, one lowercase letter, and one digit. This step is mandatory, and **you will not be able to interact with the router's WebUI before you change the password.**
4. When you change the router's password, the **Configuration Wizard** will start. The **Configuration Wizard** is a tool used to set up some of the router's main operating parameters.
5. Go to the **Status > Overview** page and pay attention to the **Signal Strength** indication (image B). To maximize the cellular performance try adjusting the antennas or changing the location of your device to achieve the best signal conditions.

A.

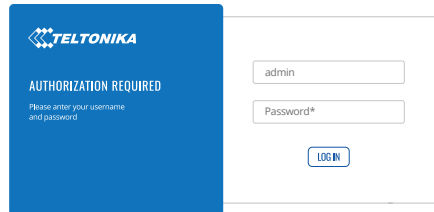

B.

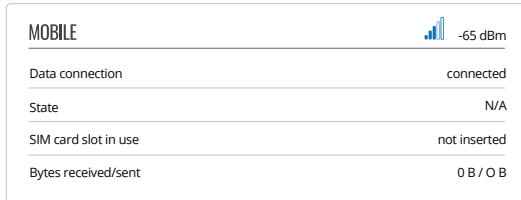

GPL

Some products of Teltonika partly contain software code developed by third parties, including software code subject to the GNU General Public License (“GPL”) version 2, version 3, GNU Lesser General Public License (“LGPL”) version 2.1 and other open source licenses.

In order to comply with the terms of the GPL, Teltonika, where applicable, offers a mail in service of a machine readable source code of the software subject to the GPL, on an optical media (CD-ROM) upon request by mail or email. Further information is provided with the relevant products or the software. You can download the free copies of the respective machine readable source code of the software which is subject to the GPL and contained in Teltonika products if you follow this internet link: <https://wiki.teltonika.lt/index.php?title=GPL>

The respective programs are distributed WITHOUT ANY WARRANTY; without even the implied warranty of MERCHANTABILITY or FITNESS FOR A PARTICULAR PURPOSE. See the respective GNU General Public License for more details.

Please choose the model and version of your Teltonika product from the list found in the provided link in order to download the source code. You can also review and print the respective GPL license terms.

If you have any more questions or suggestions regarding GPL, please contact us at gpl@teltonika.lt

SPECIFICATIONS

HARDWARE

- Quad-core ARM Cortex A7 717 MHz CPU
- 256 MB of DDR3 memory, 256 MB SPI Flash memory
- 4 pin industrial DC power socket
- USB port for external devices
- Reset/restore to default button
- 2 x SIM slots (Mini SIM - 2FF), 1.8 V/3 V, external SIM holder
- 2 x SMA for LTE, 1 x SMA for GPS antenna connector
- 8 x Ethernet LEDs, 3 x WAN type LEDs, 1 x power LED
- 3 x Mobile connection type LEDs
- 5 x Mobile signal strength indication LEDs
- Grounding screw
- Attachable DIN rail adapter

ETHERNET

- IEEE 802.3, IEEE 802.3u, 802.3az standards
- 3 x LAN ports 10/100/1000 Mbps
- 1 x WAN port (can be configured to LAN) 10/100/1000 Mbps
- Supports Auto MDI/MDIX

RADIO INFORMATION

Radio specifications	
RF technologies	DC-HSDPA, HSUPA, WCDMA, LTE, GNSS
Max RF power	30 dBm@WiFi, 24 dBm@WCDMA, 23 dBm@LTE
Bundled antennas specifications*	
WCDMA/LTE antenna	698–960/1710–2690 MHz, 50 Ω, VSWR<3, gain** 3 dBi, omnidirectional, SMA male connector
GNSS antenna	1575.42–1602 MHz, 2.2–5 VDC, VSWR<1.5, active total gain** 28 dB (typ.), RHCP polarization, SMA male connector

*Order code dependent.

**Higher gain antenna can be connected to compensate for cable attenuation when a cable is used. The user is responsible for the compliance with the legal regulations.

ELECTRICAL, MECHANICAL & ENVIRONMENTAL

Dimensions (W x D x H)	115 mm x 95 mm x 44 mm
Weight	460 g
Power supply	240VAC -> 12 VDC wall adapter
Input voltage range	9 – 50 VDC
Power consumption	< 18 W
Operating temperature	- 40 °C to 75 °C
Storage temperature	- 45 °C to 80 °C
Operating humidity	10 % to 90 % Non-condensing
Storage humidity	5 % to 95 % Non-condensing

SETUP WIZARD

After logging in to the router's WebUI, you will be prompted to change the default password and the Setup Wizard will start:

By clicking the Skip button, you will skip all the Setup Wizard steps. You can find the Setup Wizard in System/-Setup Wizard.

1. Choose your time zone and sync the router's time with the browser if needed.

TIME ZONE SETTINGS

Current system time Thu Mar 7 14:49:06 2019 [SYNC WITH BROWSER](#)

Time zone

[SKIP](#) [NEXT](#)

2. Default LAN settings are recommended unless you have specific requirements for your LAN network.

LAN CONFIGURATION

IP address

Netmask

LAN CONFIGURATION

IP address off on

Start

Limit

Lease time

Units

[< BACK](#) [SKIP](#) [NEXT](#)

3. If you have inserted a SIM card into the router. Set the settings as provided by your Mobile Operator. Otherwise, click the Next button.

MOBILE CONFIGURATION | MOB1S1A1

APN

PIN

Authentication Type

4. You will need an account at <https://rms.teltonika.lt> to complete this step. Click the Skip button if you do not wish to configure RMS at this time.

RMS SETTING

Connection type ?

Hostname

Port

STATUS

Management status	Enabled
Connection State	Connected
Serial number	1000002019
Lan MAC	00:1E:42:00:00:19



DECLARATION OF CONFORMITY



RUTX09 router must be used in compliance with any and all applicable national and international laws and with any special restrictions regulating the utilization of the communication module in prescribed applications and environments.

[EN] English	Hereby, TELNIKA declares that this RUTX09 is in compliance with the essential requirements and other relevant provisions of Directive RED.
[BG] Bulgarian	С настоящето, TELNIKA декларира, че RUTX09 е в съответствие със съществените изисквания и другите приложими разпоредби на Директива RED.
[CZ] Czech	TELNIKA tímto prohlašuje, že RUTX09 splňuje základní požadavky a všechna příslušná ustanovení Směrnice RED.
[DE] German	Hiermit erklärt TELNIKA dass sich das Gerät RUTX09 in Übereinstimmung mit den grundlegenden Anforderungen und den übrigen einschlägigen Bestimmungen der Richtlinie RED befindet.
[DK] Danish	Undertegnede TELNIKA erklærer herved, at følgende udstyr RUTX09 overholder de væsentlige krav og øvrige relevante krav i direktiv RED.
[EE] Estonian	Käesolevaga kinnitab TELNIKA seadme RUTX09 vastavust direktiivi RED põhinõuetele ja nimetatud direktiivist tulenevatele teistele asjakohastele sätetele.
[ES] Spanish	Por la presente, TELNIKA declara que este RUTX09 cumple con los requisitos esenciales y otras exigencias relevantes de la Directiva RED.
[FI] Finnish	TELNIKA vakuuttaa täten että RUTX09 tyyppinen laite on direktiivin RED oleellisten vaatimusten ja sitä koskevien direktiivin muiden ehtojen mukainen.
[FR] French	TELNIKA déclare que cette RUTX09 est conforme aux exigences essentielles et aux autres dispositions pertinentes de la directive RED.
[GR] Greek	ΜΕ ΤΗΝ ΠΑΡΟΥΣΑ Ο ΚΑΤΑΣΚΕΥΑΣΤΗΣ ΤΕΛΝΙΚΑ ΔΗΛΩΝΕΙ ΟΤΙ ΤΟ RUTX09 ΣΥΜΜΟΡΦΩΝΕΤΑΙ ΠΡΟΣ ΤΙΣ ΟΥΣΙΩΔΕΙΣ ΑΠΑΙΤΗΣΕΙΣ ΚΑΙ ΤΙΣ ΛΟΙΠΕΣ ΣΧΕΤΙΚΕΣ ΔΙΑΤΑΞΕΙΣ ΤΗΣ ΟΔΗΓΙΑΣ RED.
[HU] Hungarian	A TELNIKA ezennel kijelenti, hogy a RUTX09 típusú berendezés teljesíti az alappvető követelményeket és más RED irányelvben meghatározott vonatkozó rendelkezéseket.
[IT] Italian	Con la presente TELNIKA dichiara che questo RUTX09 è conforme ai requisiti essenziali ed alle altre disposizioni pertinenti stabilite dalla direttiva RED.
[LT] Lithuanian	Šiuo dokumentu UAB TELNIKA deklaruoja, kad šis RUTX09 atitinka esminius reikalavimus ir kitas RED Direktyvos nuostatas.
[LV] Latvian	Ar šo TELNIKA deklarē, ka RUTX09 atbilst Direktīvas RED būtiskajām prasībām un citiem ar to saistītajiem noteikumiem.
[NL] Dutch	Hierbij verklaart TELNIKA dat het toestel I RUTX09 in overeenstemming is met de essentiële eisen en de andere relevante bepalingen van richtlijn RED.
[NO] Norwegian	TELNIKA Erklærer herved at RUTX09 er i samsvar med de grunnleggende krav og øvrige relevante krav i direktiv RED.
[PL] Polish	Niniejszym TELNIKA deklaruje że RUTX09 jest zgodny z zasadniczymi wymaganiami i innymi właściwymi postanowieniami Dyrektywy RED.
[PT] Portuguese	Eu, TELNIKA declaro que o RUTX09 cumpre os requisitos essenciais e outras provisões relevantes da Directiva RED.
[RO] Romanian	Prin prezenta, TELNIKA declară că aparatul RUTX09 este în conformitate cu cerințele esențiale și cu alte prevederi pertinente ale Directivei RED.
[SE] Swedish	Härmed intygar TELNIKA att denna RUTX09 är i överensstämmelse med de väsentliga egenskapskrav och övriga relevanta bestämmelser som framgår av direktiv RED.
[SI] Slovenian	TELNIKA izjavlja, da je ta RUTX09 v skladu z bistvenimi zahtevami in drugimi relevantnimi določili direktive RED.

Declaration of Conformity (DoC) can be obtained by visiting <https://telnika.lt/product/rutx09/>

- [EN]** Instruction Manual: Connect the power adapter to turn on the device. Open 192.168.1.1 in your web browser to configure it. More information on <https://wiki.teltonika.lt>
- [BG]** Инструкции: Свържете адаптера на захранване, за да включите устройството. Отворете 192.168.1.1 в уеб браузър, за да настроите продукта. Повече информация в <https://wiki.teltonika.lt>
- [CZ]** Návod k použití: Připojte napájecí adaptér k zapnutí přístroje. Otevřete 192.168.1.1 ve webovém prohlížeči pro konfiguraci produktu. Více informací najdete v <https://wiki.teltonika.lt>
- [DE]** Bedienungsanleitung: Verbinden Sie das Netzteil, um das Gerät einzuschalten. Öffnen Sie 192.168.1.1 in einem Web Browser, um das Produkt zu konfigurieren. Weitere Informationen im <https://wiki.teltonika.lt>
- [DK]** Instruktionsbog: Tilslut strømadapteren for at tænde for enheden. Åbn 192.168.1.1 i en webbrowser til at konfigurere produktet. Mere information i <https://wiki.teltonika.lt>
- [EE]** Kasutusjuhend: Ühendage toiteadapter seadme sisselülitamiseks. Avatud 192.168.1.1 in veebilehitseja seadistada toodet. Rohkem teavet <https://wiki.teltonika.lt>
- [ES]** Manual de instrucciones: Conecte el adaptador de alimentación para encender la unidad. Abra 192.168.1.1 en un navegador web para configurar el producto. Más información en <https://wiki.teltonika.lt>
- [FI]** Käyttöohje: Kytke virtalähde päälle laitteeseen. Avaa 192.168.1.1 in selaimen määräämää tuotteen. Lisää tietoa <https://wiki.teltonika.lt>
- [FR]** Mode d'emploi: Connectez l'adaptateur d'alimentation pour allumer l'appareil. Ouvrez 192.168.1.1 dans un navigateur Web pour configurer le produit. Plus d'informations dans <https://wiki.teltonika.lt>
- [GR]** εγχειρίδιο οδηγιών: Συνδέστε τον προσαρμογέα τροφοδοσίας για να ενεργοποιήσετε τη μονάδα. Ανοίξτε 192.168.1.1 σε ένα πρόγραμμα περιήγησης στο Web για να διαμορφώσετε το προϊόν. Περισσότερες πληροφορίες στο <https://wiki.teltonika.lt>
- [HU]** Használati utasítás: Csatlakoztassa a hálózati adaptert a készülék bekapcsolásához. Megnyitása 192.168.1.1 egy webböngészőben beállítani a terméket. Több információ <https://wiki.teltonika.lt>
- [IT]** Manuale di istruzioni: Collegare l'adattatore di alimentazione per accendere l'unità. Aprire 192.168.1.1 in un browser Web per configurare il prodotto. Maggiori informazioni in <https://wiki.teltonika.lt>
- [LT]** Naudojimosi instrukcija: Prijunkite maitinimo adapterį, įjunkite įrenginį. Internete naršykite atidarykite adresą 192.168.1.1 - galite konfiguruoti gaminį. Daugiau informacijos rasite <https://wiki.teltonika.lt>
- [LV]** Lietošanas instrukcija: Pievienojiet Strāvas adapteri, lai ieslēgtu ierīci. Atvērt 192.168.1.1 ar interneta pārlūku, lai konfigurētu produktu. Plašāka informācija <https://wiki.teltonika.lt>
- [NL]** Handleiding: Sluit voedingsadapter aan op het apparaat in te schakelen. Open 192.168.1.1 in een webbrowser om het product te configureren. Meer informatie in <https://wiki.teltonika.lt>
- [NO]** Bruksanvisningen: Koble strømadapteren for å slå på enheten. Åpne 192.168.1.1 i en nettleser for å konfigurere produktet. Mer informasjon på <https://wiki.teltonika.lt>
- [PL]** Instrukcja obsługi: Podłącz adapter zasilania, aby włączyć urządzenie. Otwórz 192.168.1.1 w przeglądarce internetowej, aby skonfigurować urządzenie. Więcej informacji w <https://wiki.teltonika.lt>
- [PT]** Manual de instruções: Conecte o adaptador de alimentação para ligar o aparelho. Abra 192.168.1.1 em um navegador da web para configurar o produto. Mais informações em <https://wiki.teltonika.lt>
- [RO]** Instrucțiuni de utilizare: Conectați adaptorul de alimentare pentru a porni aparatul. Deschide 192.168.1.1 întrun browser web pentru a configura produsul. Mai multe informații în <https://wiki.teltonika.lt>
- [SE]** Instruktionsmanual: Anslut nätadapter tern för att slå på enheten. Öppna 192.168.1.1 i en webbläsare för att konfigurera produkten. Mer information på <https://wiki.teltonika.lt>
- [SI]** Navodila: Priključite napajalnik za vklop naprave. Odprite 192.168.1.1 v spletnem brskalniku nastaviti izdelek. Več informacij v <https://wiki.teltonika.lt>
- [SK]** Návozd na použitie: Pripojte napájací adaptér k zapnutiu prístroja. Otvorte 192.168.1.1 vo webovom prehliadači pre konfiguráciu produktu. Viac informácií nájdete v <https://wiki.teltonika.lt>

For more information visit www.teltonika.lt



This sign on the package means that all used electronic and electric equipment should not be mixed with general household waste.